



FORTICRETE MASONRY

CONTENTS

Forticrete Introduction	3
Bedding and Jointing	4
Trial Panel	4
Preparation and building of reference panels.....	5
Mortar Mix	6
Protection of Block work.....	7
Movement joints	7
Wall Ties.....	7
Damp-proof courses (DPC's) and cavity trays	8
Weepholes	8
Design	8
Durability	8
Supervision.....	8
Workmanship	8
Blending	10
Fire rating.....	11
Cutting on Site	11
Cutting service	11
Technical Service	11
Checking deliveries of masonry products.....	11
Colour and Efflorescence.....	12
Standards.....	13
Coulour Range.....	14 -15
Block Range	16 - 21



Forticrete Introduction

Forticrete architectural masonry has been manufactured in Ireland by Roadstone for over 40 years.

Forticrete features an aesthetically pleasing external or internal masonry finish that has stood the test of time. Due to its unique combination of 12 colours, 6 textures and almost 100 block types, there is a vast array of bespoke design possibilities.

Used extensively for commercial buildings, schools, boundary walls and domestic dwellings throughout Ireland, Forticrete can be used to form the external leaf of a cavity wall construction and does not require plastering or painting.

Forticrete offers an opportunity to create designs using a large combination of colours, sizes and textures to create outstanding building facades.



Bedding and Jointing

The selection and finish of mortar joints in masonry effects the appearance of the finished work. Consistent finishing and colour of the joints is essential to guarantee a uniform finish.

Forticrete units should be laid on a full bed of mortar with both horizontal and vertical joints filled and compacted. The preferred joint finish and profile should be bucket handle with a nominal thickness of 10mm.

Weather struck joint profile is also acceptable for all exposures, brushed flush finish can also be used with split masonry. Recessed joint profile is not recommended for severe exposure.

The tooling and finishing of joints should be carried out when the mortar is slightly hard and at regular intervals to maintain consistency of finish and colour.

Trial Panel

A trial panel as per I.S. EN 771-5 should be built and retained until completion of works (For National durability requirements please refer to S.R.325 2013+A2:2018)





Preparation and building of reference panels

Prepare a solid base for the building of a reference panel where it can be viewed from 3 metres in an area with adequate light and can remain undamaged for the duration of the contract. Build a reference panel from masonry product reasonably representative of the average quality of the whole order to be delivered, either chosen by the supplier or randomly sampled. At least six packs shall be selected at random from the consignment.

The packaging shall be removed and an equal number of units shall be sampled at random from within each of the opened packs in order to give the required number of units without any consideration being given to the quality of those selected except that units damaged in transit shall not be selected. A reference panel should consist of at least 1.7 square metres. Build the reference panel to the desired standard expected throughout the contract to incorporate the relevant bond, mortar colour and joint profile. Reference panels should be protected from saturation.

Note: In finished brickwork the mortar joint accounts for approximately 17% of the surface area, hence the importance of mortar colour selection. Consistent mortar supply is of utmost importance. The finish of the joints by rubbing up or raking out of the joint should be executed in a consistent manner. Judgement of mortar should only be made when the panel has dried out sufficiently to represent the final colour.

Mortar Mix

Masonry mortar should be selected according to the exposure condition of the masonry and design requirement. For general use (passive) M4 Mortar with colouring pigment if required. For moderate and severe exposure use M6 Mortar with colouring pigment if required.

When site batching it is essential to use a clean uncontaminated sand that comply with I.S. EN 13139 Aggregates for Mortar.

I.S. EN 1996-1-1 - Table NA.3 (Amended) - Acceptable Assumed Equivalent Mixes for Prescribed Masonry Mortars

Compressive strength Class*	Equivalent Prescribed Mortars (Proportion of Materials by Volume)(See note)	
	Cement: Lime: Sand with or without Air Entrainment	Cement: Sand: Sand with or without Air Entrainment
M6	1 : ½ : 4 to 4½	1 : 3 to 4
M4	1 : 1 : 6	1 : 6
M4 Brick (fine mortar)	1 : 1 : 5	1 : 5

The number following the M is the compressive strength for the class at 28 days in N/mm².

NOTE: When the sand portion is given as, for example, 5 to 6, the lower figure should be used with sands containing a higher proportion of fines whilst the higher figure should be used with sands containing a lower proportion fines.

Roadstone supply a range of TRM (Trowel Ready Mortar) and Flomix Silo Mortars that are CE marked and are tested to ensure they comply with Roadstones exating quality standards, Roadstone mortars are produced with traditional natural sands that comply with S.R. 18 "Guidance on the use of I.S. EN 13139. Aggregates for mortar".

Information and source locations available on www.roadstone.ie

Protection of Block work

Handling, storage and protection of masonry products

Unload masonry products to a level hard standing surface leaving branding and packaging in place to avoid damage such as chipping, soiling or breakage. Protect masonry products from rain, splashing by vehicles and mortar mixing. At the end of each working day and in periods of rainfall, ensure that opened packs and stacks of masonry products around the site are protected to avoid saturation.

Newly erected masonry should be protected to prevent mortar being washed out of the joints by rain. Walls should be prevented from becoming saturated by covering the top of the wall with waterproof sheets. Block laying should be discontinued when the air temperature is at 3°C or below unless precaution are taken to ensure that the mortar temperature is not less than 4°C when laid and that the work is protected from freezing.

Movement joints

As with all masonry products, control joints are required to relieve stress caused mainly by moisture movement and thermal movement. Panel shape will determine the size spacing of joints which should not normally exceed 7 Meter centres. Detailed information on the allowance for movement in masonry refer to Eurocode 6 I.S. EN 1996-1-1 General rules for reinforced and unreinforced masonry structures, + National Annex, S.R. 325: 2014 Recommendations for the design of Masonry structures in Ireland to Eurocode 6

Wall ties

The selection of wall ties depends on many factors. These include the type of masonry to be tied, the cavity width, the type and height of the building and its geographical location.

In general the requirements of S.R.325 2013+A2:2018 should be followed .

The leaves of a cavity wall should be tied together with wall ties complying with I.S. EN 845. All ties should be embedded to a minimum depth of 50 mm in the horizontal mortar joints at the time the course is laid, with a minimum mortar embedment of 40 mm to the other face of the wall. For example, a 200mm long wall tie is suitable for cavities from 50-75mm. The ties should be placed at a frequency of not less than those given in the National Annex to I.S. EN 1996-1-1. Additional ties should be provided within 225 mm of all openings so that there is one for each 300 mm of height of opening. Consideration should be given to providing additional flexible ties across the cavity adjacent to movement joints.

Where hollow blockwork is used to form one or both leaves of a cavity wall, care should be taken to ensure that ties are placed on solid sections and that an appropriate tie type is used in order to ensure adequate anchorage. The height above any DPC of the first row of cavity ties should not exceed 225 mm. The maximum height of wall panel above the top row of cavity ties should not exceed 225 mm. Where possible, ties should not be installed at DPC level. Reshaping or bending of wall ties should not be permitted unless it can be shown that this does not give rise to adverse effects on the strength, anchorage or durability of the ties. Each tie should be so placed that drips will cause water drops to fall within the cavity and away from any cavity fill present.

Damp-proof courses (DPC's) and cavity trays

Materials for damp-proof courses (DPC's) should comply with the relevant standard as established in S.R.325 2013+A2:2018 Table 3. The criteria for suitability of materials for DPC's are set out in 5.5.4 and Table 13. A DPC in a building is intended to provide a barrier to the passage of water from the exterior of the building to the interior, in every external wall, a DPC should be provided at least 150 mm above the finished level of the external ground. Horizontal & vertical DPC's should be used around all openings and preformed cavity trays should be used in appropriate location to prevent the passage of moisture to the internal leaf.

Weepholes

It is essential to form weepholes in the outer leaf immediately above the DPC's, cavity tray's and lintels. Proprietary weephole formers should be used at not greater than 1 metre intervals in the course of units immediately above joint, with not less than two weepholes over each opening.

Design

For structural use of masonry, the designer should consider the level of construction control to be adopted for guidance see I.S. EN 1996-2.

Durability

Suitable for use in all normal building applications Refer to I.S. SR 325 2013+A2:2018

Rated to MX3.2/F2 – Suitable for use in severe exposure

Supervision

The design recommendations given in section five of I.S. EN 1996-2 assume that the quality of workmanship described in section six is achieved, and appropriate supervision should ensure that this quality is achieved. In the case of the structural use of masonry, the designer should consider the level of construction control to be adopted (see NA to I.S. EN 1996-1-1). The quality of workmanship actually achieved both when constructing masonry and when installing any insulation product, is a very important factor affecting resistance to rain penetration. The workmanship should be in accordance with BS 8000-3.

Workmanship

The workmanship recommendations of S.R.325 2013+A2:2018 should normally be followed, but for alternative and in some instances additional information on basic masonry workmanship, see BS 8000-3.



Natural colour Forticrete blocks: Smooth Plinth, Split-Fluted Bands, Split-Faced Field, Smooth Quoins

Blending

Blending from at least 3 bales is recommended. Where appropriate Forticrete masonry should be retained for blending with subsequent deliveries. Forticrete masonry is made with natural occurring aggregates which have inherent colour variation therefore blending is essential to avoid banding

Performance in accordance with I.S. EN 771-3

Characteristic	Declared Performance	Harmonised Technical Specification
Dimensional Tolerance	D1 (+3mm, -3mm)	I.S. EN 772-16
Configuration	Category 1 to EN 1996-1-1 Group 1 or Group 2 See block diagram(s)	EN 1996-1-1
Gross Density (Direct Airborne Sound Insulation)	>1900kg/m ³	I.S. EN 772-13
Net Density (Direct Airborne Sound Insulation)	>1900kg/m ³	I.S. EN 772-13
Compressive Strength (Mean)	> 13N in vertical orientation	I.S. EN 772-1 (7.3.5)
Thermal Conductivity	1.01 - 1.19 W/mK (λ_{10} ,dry)	I.S. EN 1745 Annex A
Durability against freeze/thaw	F2 – Suitable for use in severe exposure	N/A
Water Absorption	NPD	N/A
Moisture Movement	< 0.6 mm/m	I.S. EN 772-14
Water Vapour Permeability	5/15 μ	I.S. EN 1745 Annex A
Reaction To Fire	Class A1	Based on Commission Decision 200/605 EC amending 96/603 EC
Shear Bond Strength	0,15N/mm ² (Tabulated)	I.S. EN 998-2
Dangerous Substances	NPD	N/A

Fire rating

For the fire ratings of walls constructed using Forticrete units refer to the national annex of I.S. EN 1996-1-2 General rules, Structural fire design. Fire rating up to 4 hours can be achieved for loadbearing and non-loadbearing walls, constructed with Forticrete Masonry units.

Cutting on Site

Blocks used for facing work shall be cut with a masonry saw. Cut pieces should be thoroughly washed clean and allow to dry before use. Split units can be cut with a bolster or mechanical splitter. Appropriate site specific health and safety procedures should be used when cutting masonry units.

Cutting service

Roadstone offers a factory cutting service, for details Contact your local Roadstone Sales Representative.

Technical Service

Roadstone's Architectural Products Team provide experienced technical service nationwide to the designer and builder at all stages of design and construction.

Checking deliveries of masonry products

Immediately on receipt of a consignment of Forticrete masonry check delivery dockets against specifications or orders and in particular that the delivery is of the correct masonry type, quantity and quality. Any colour variation is within acceptable limits. The masonry products are within the specified limits of size. Any minor blemishes, such as chips and surface cracks are within acceptable limits.

If in doubt about any of the above inform the supplier immediately.



Colour and Efflorescence

Roadstone is not responsible for the naturally occurring phenomenon of efflorescence nor the normal variation in colour or texture inherent in concrete products.

Table of properties / main masonry units

MAIN BLOCK WEIGHTS IN KILOGRAMMES							
400 RANGE				450 RANGE			
Ref	Thickness (mm)	Average Weight (Kg)	Approx lald wall weights inc. mortar (kg/m ²)	Ref	Thickness (mm)	Average Weight (Kg)	Approx lald wall weights inc. mortar (kg/m ²)
K1	90	14.0kg	188	D1	100	20.0kg	210
P4	140	17.4kg	202	H3	140	18.3kg	
R3	190	18.0kg	245	F3	215	24.6kg	267
R4	190	23.6kg	320	SF51	107	20.0kg	210
SF 41	95	14.3	192	SF53	220	24.8kg	267
SF 43	195	18.6kg	256	S53	107	10.0kg	219
S7	95	15.8kg	211	S55	107	14.0kg	230
S9	195	19.4kg	265	S57	107	22.0kg	230
				S59	220	24.8kg	267





**Forticrete Charcoal
Simulated Stack Bond**

Standards

I.S. EN 771-3 Specification for masonry units - Part 3.

The current Irish design code for masonry is Eurocode 6. I.S. EN 1996-1-1 General rules for reinforced and unreinforced masonry structures.

I.S. EN 1996-1-2 General rules. Structural fire design.

I.S. EN 1996-2: Design considerations, selection of materials and execution of masonry.

S.R. 325: Recommendations for the design of Masonry structures in Ireland to Eurocode 6 provides recommendations for detailing and exposure/durability tables.

I.S. EN 998-2 Specification for mortar for masonry — Part 2: Masonry mortar.

S.R. 18: Guidance on the use of I.S. EN 13139. Aggregates for mortar

Sample Specification.

The block shall be Forticrete Architectural Masonry Ref No., S57. Size: 440x215x107mmm thick, Profile: Split face. Colour: Natural colour. Laid: stretcher bond using a bucket handle joint profile. Mortar: natural coloured mortar in accordance with table NA3 of I.S. EN 1996-1-1 or as indicated by engineer.

FORTICRETE ARCHITECTURAL

COLOUR RANGE

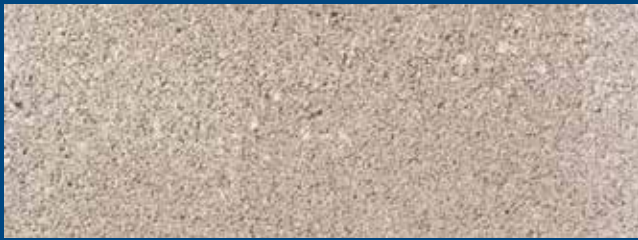

Natural



Heather



Straw



Rust

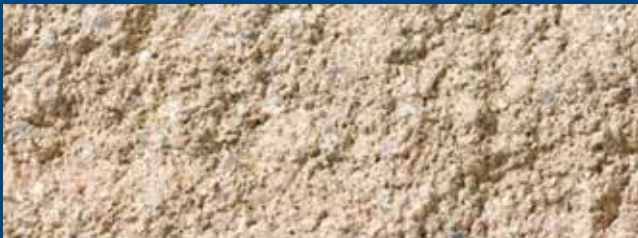

Buff



Charcoal

TEXTURE RANGE



Simulated Half Split



Split Ribbed



Split Fluted

NOTE: Please note that the colour swatches shown in this brochure are only an indicative representation and do not reflect the true colour of the Forticrete block. For colour samples please contact your local sales representative.



Honey



Brown



White



Terracotta



Autumn Blend



Russet Blend



Grooved



Split



Smooth

STANDARD 450 RANGE

SMOOTH MASONRY

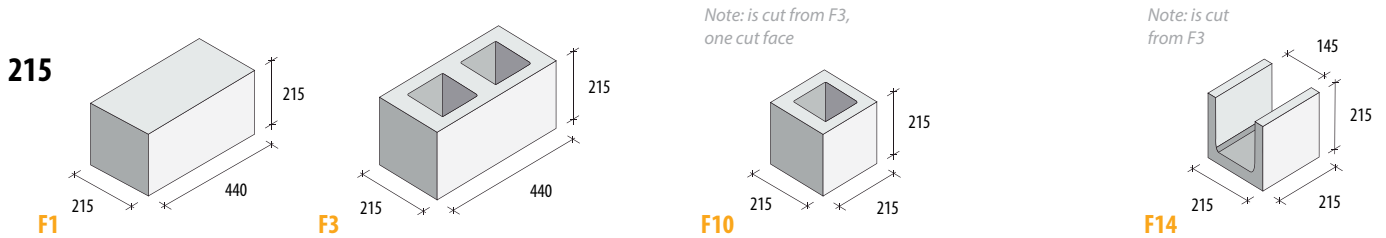
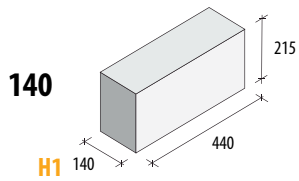
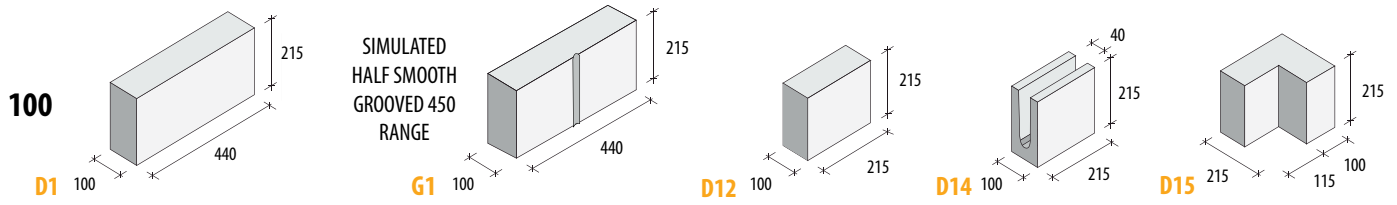

TEXTURED MASONRY

SPLIT 450 RANGE

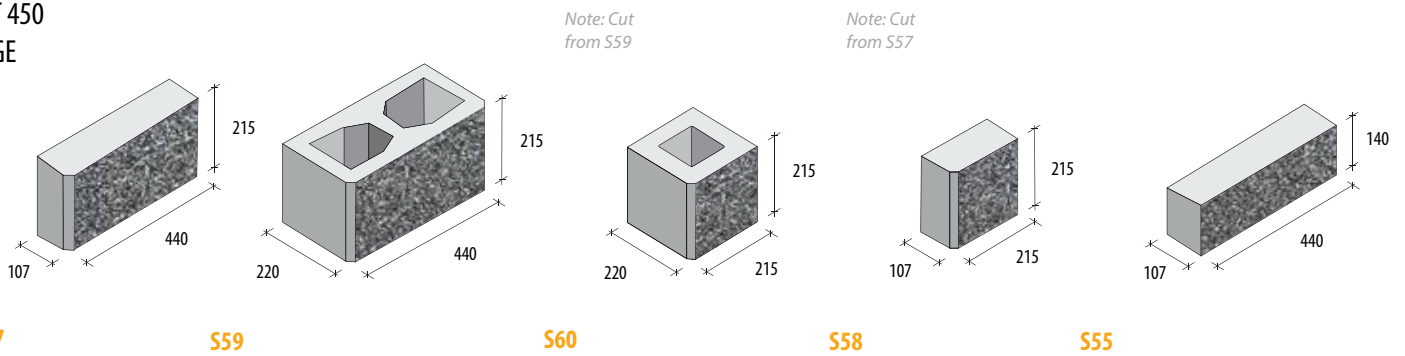

SPLIT FLUTED 450 RANGE

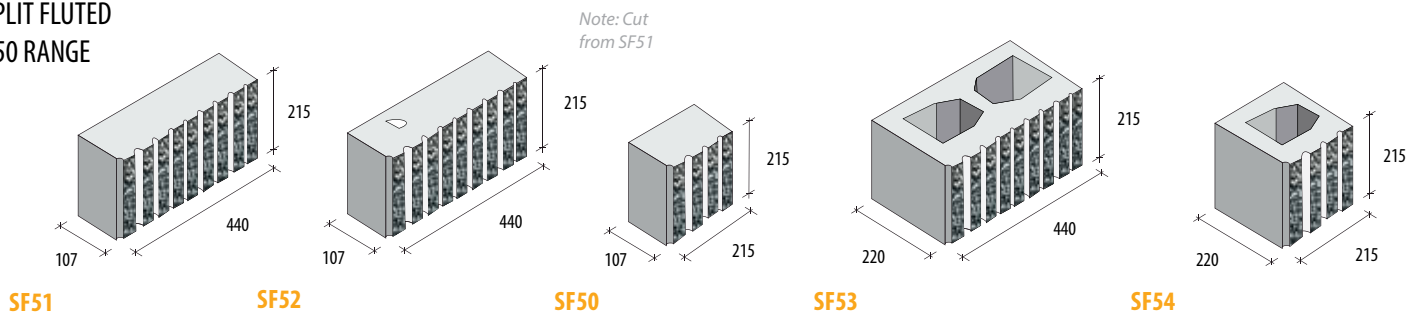

STANDARD 450 RANGE

Co-Ordinating size: 450mm x 225mm - 9.88 blocks per square metre.
 Actual Face Size: 440mm x 215mm.

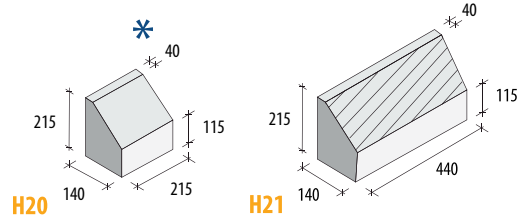
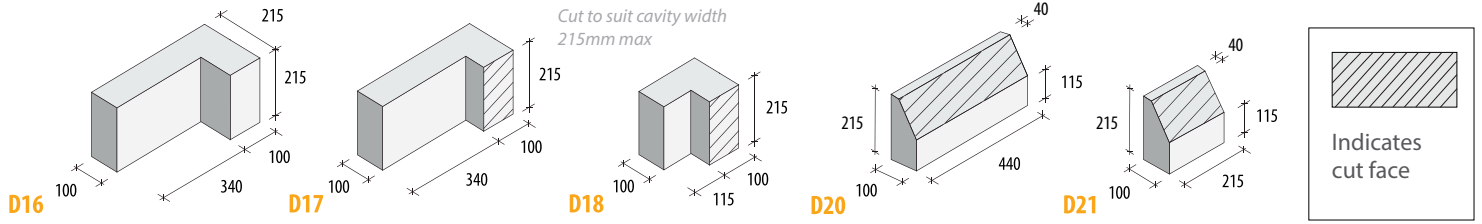

*
Sills can be supplied with throating.

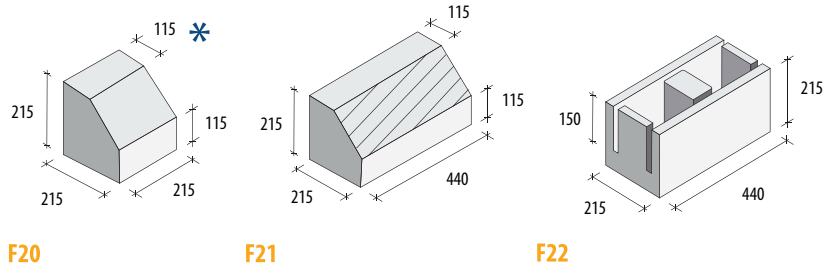

Co-Ordinating size: 450mm x 225mm - 9.88 blocks per square metre.
 Actual Face Size: 440mm x 215mm.

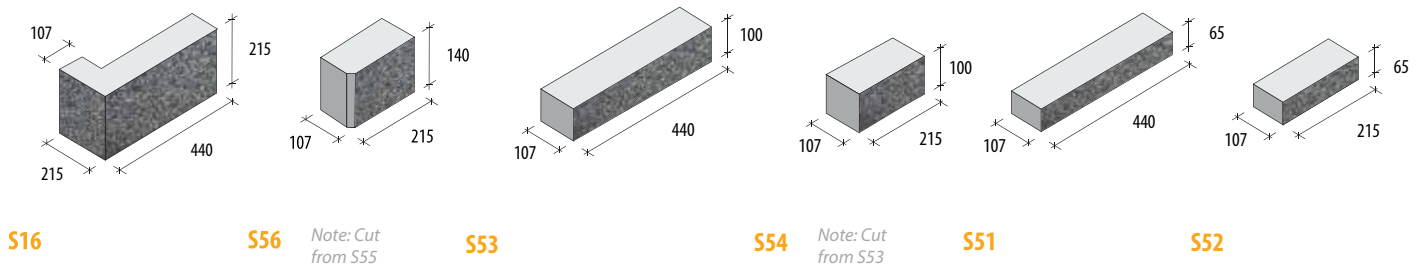

SPLIT RIBBED
450 BLOCK

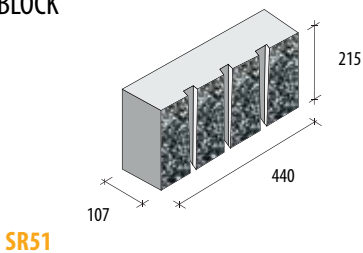

SIMULATED HALF
SPLIT 450 BLOCK

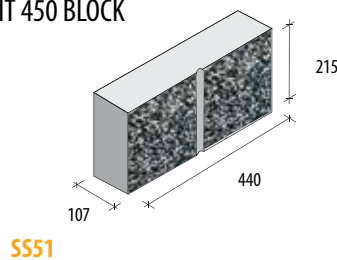

MITRED CORNER
BLOCKS AVAILABLE

STANDARD 450 RANGE

STANDARD UNITS

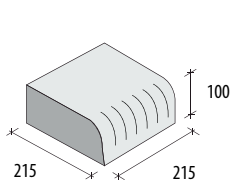

X1

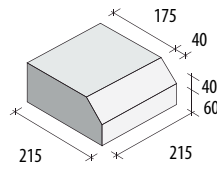

X2

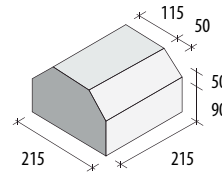

X3

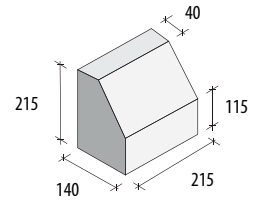

H20

EXTERNAL CORNERS

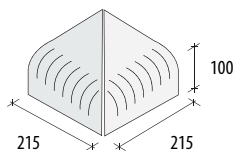

X1E

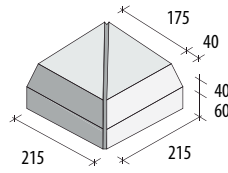

X2E

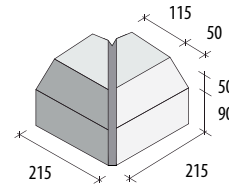

X3E

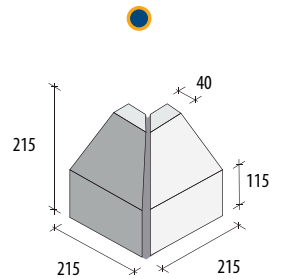

H20E

INTERNAL CORNERS

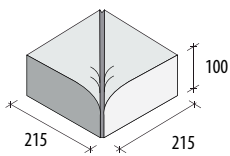

X1F

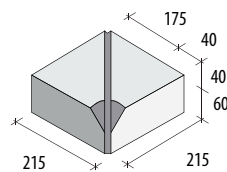

X2F

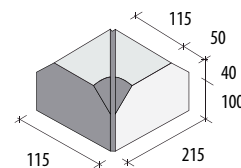

X3F

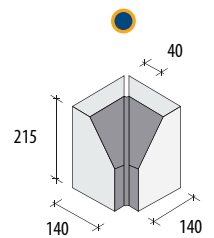

H20F

UNITS CAN BE CUT UP TO 215MM WIDE

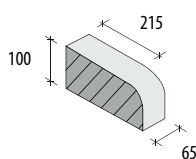

X1B

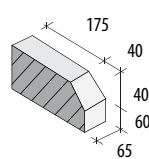

X2B

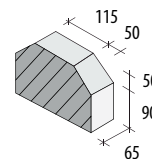

X3B

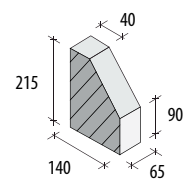

H20B

STANDARD 450 RANGE

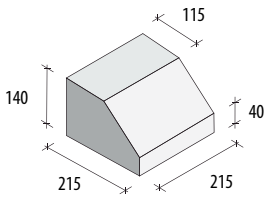

H20

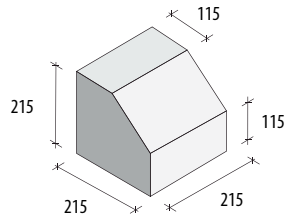

F20

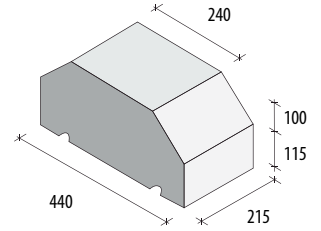

F20D

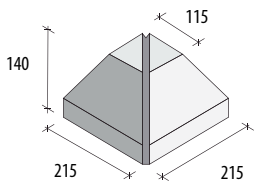

H20C

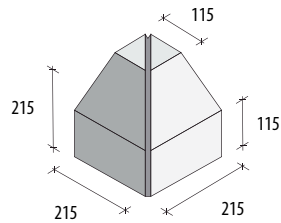

F20E

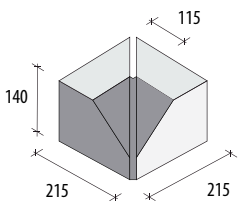

H20D

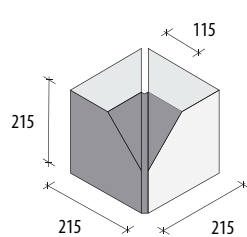

F20F



NOTE:
External and internal angles
are shown at 90° but any
angle can be supplied

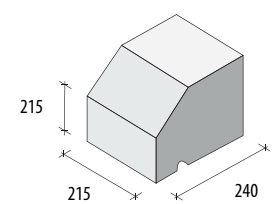

F20DS

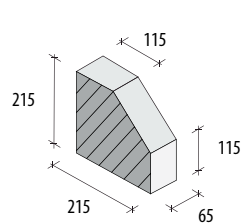

F20B

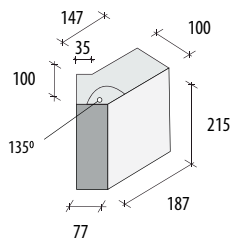

X45

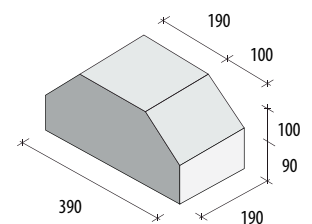

R20D (MODULAR RANGE)

MODULAR 400 RANGE

SMOOTH MASONRY

ACTUAL THICKNESS	SOLID	HOLLOW	SPECIAL PERFORMANCE (S.P.) HOLLOW	HALF LENGTH HOLLOW	HALF LENGTH (S.P.) HOLLOW	LINTEL (CUT OR MOULDED)	HALF LENGTH QUOIN
90							
140							
190							

TEXTURED MASONRY

SPLIT 400 RANGE					
	S7	S9	S10 <i>Note: Cut from S9</i>	S8 <i>Note: Cut from S7</i>	
SPLIT FLUTED 400 RANGE					
	SF41	SF42	SF40	SF43 <i>Note: cut from SF41</i>	SF44 <i>Note: Cut from SF53</i>

MODULAR 400 RANGE

Co-Ordinating size: 400mm x 200mm - 12.5 blocks per square metre.
Actual Face Size: 390mm x 190mm.

QUOIN

CAVITY CLOSER

HALF LENGTH CAVITY CLOSER

HALF LENGTH CILL

CILL (CUT FACE ONLY)

BOND BEAM (SEE NOTE 1)

135° QUOIN SQUINT

Cut to suit cavity width 190 mm max.

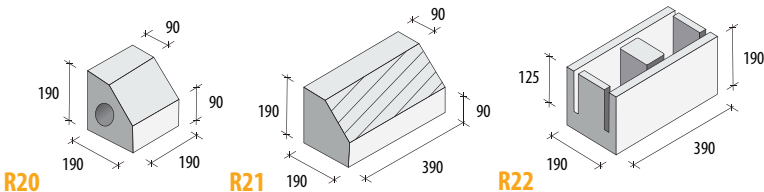
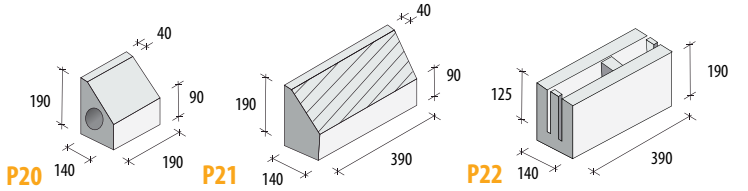
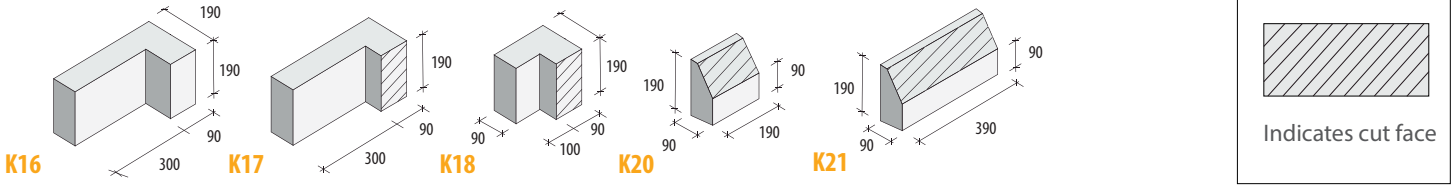

Co-Ordinating size: 400mm x 200mm - 12.5 blocks per square metre.
Actual Face Size: 390mm x 190mm.

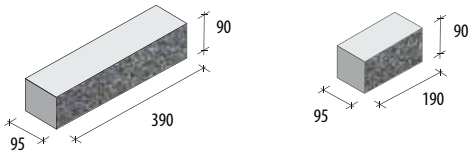

S3

S4 Note: Cut from S3

Special detailed sills are available in the 400 range. Their equivalent code no's are as follows:

450 range	400 range
H20	P20
H20E	P20E
H20F	P20F
H20C	P20C
H20D	P20D
F20	R20
F20E	R20E
F20F	R20F



www.roadstone.ie

Phone: 01 4041200 - Fortunestown, Tallaght, Dublin 24.

Email: info@roadstone.ie



This publication is for information purposes only. The information contained herein is offered in good faith and is believed to be accurate. However, no representations or warranties, express or implied, are given by Roadstone, its directors, employees or advisors as to the accuracy, reliability or completeness of the information contained herein or any other written or oral information which has been or may be made available. Accordingly, none of Roadstone, its directors, employees or advisors accept any responsibility or liability whatsoever resulting from the information contained in this publication. Roadstone reserve the right to seek indemnification from any persons to whom this publication has been furnished in respect of any third party claims, losses or demands that may be made against Roadstone.