



ROADSTONE
PAVING

RETAIL OUTLET LOCATIONS

ROADSTONE PAVING

Nationwide delivery

ROADSTONE RETAIL LOCATIONS

Open to the public

ORDERING

To view the full range of paving
or to get a quote now visit

www.roadstone

Nationwide order line **061 377 217**





PAVING BLOCKS

- 4-5 Milan Paving
- 6-9 Castlestone
- 10-11 Thomond
- 12-13 Urbana™
- 14-15 Urbana™ Setts
- 16-17 Verona Paving & Setts
- 18 Cobblesett
- 19 Castlestone Setts

AQUAFLOW PAVING

- 20 Principles of SuDS
- 21-34 Aquaflow Permeable Paving

KERBING & EDGING

- 35 Kerb Block
- 36 Castlestone Kerb
- 37 Verona Kerb
- 38 Channel Block

PAVING FLAGS

- 39 Plain Flags
- 40 Sablé Flags
- 41 Hazard Tactile Warning Flags

ACCESSORIES & COMPLIMENTARY PRODUCTS

- 42 Jointing Sands, Compounds and Sealants
- 43 Recessed Manhole Covers

GENERAL INFORMATION

- 44 Rodstone Cool Paving
- 45 Sample Paving Layouts
- 46-49 Maintenance
- 50 Other Roadstone Products
- 51 Product Selector



Pedestrian



Light Vehicle

MILAN PAVING

Linear paving to suit residential and commercial projects



White Granite



Natural



Midnight



Silver Granite

Product Technical data

Size	Depth	Laid Quantity (per m ²)	Quantity (per bale)	Bale size (m ²)
480x120mm & 360x120mm	60mm	9.9 units of each size = 1m ²	108 pieces of each size	10.88
480x120mm & 360x120mm	80mm	9.9 units of each size = 1m ²	90 pieces of each size	9.07

Milan Midnight and White Granite with Verona Midnight Setts at perimeter



Milan Silver Granite



Milan Natural & White Granite



Milan Natural & White Granite

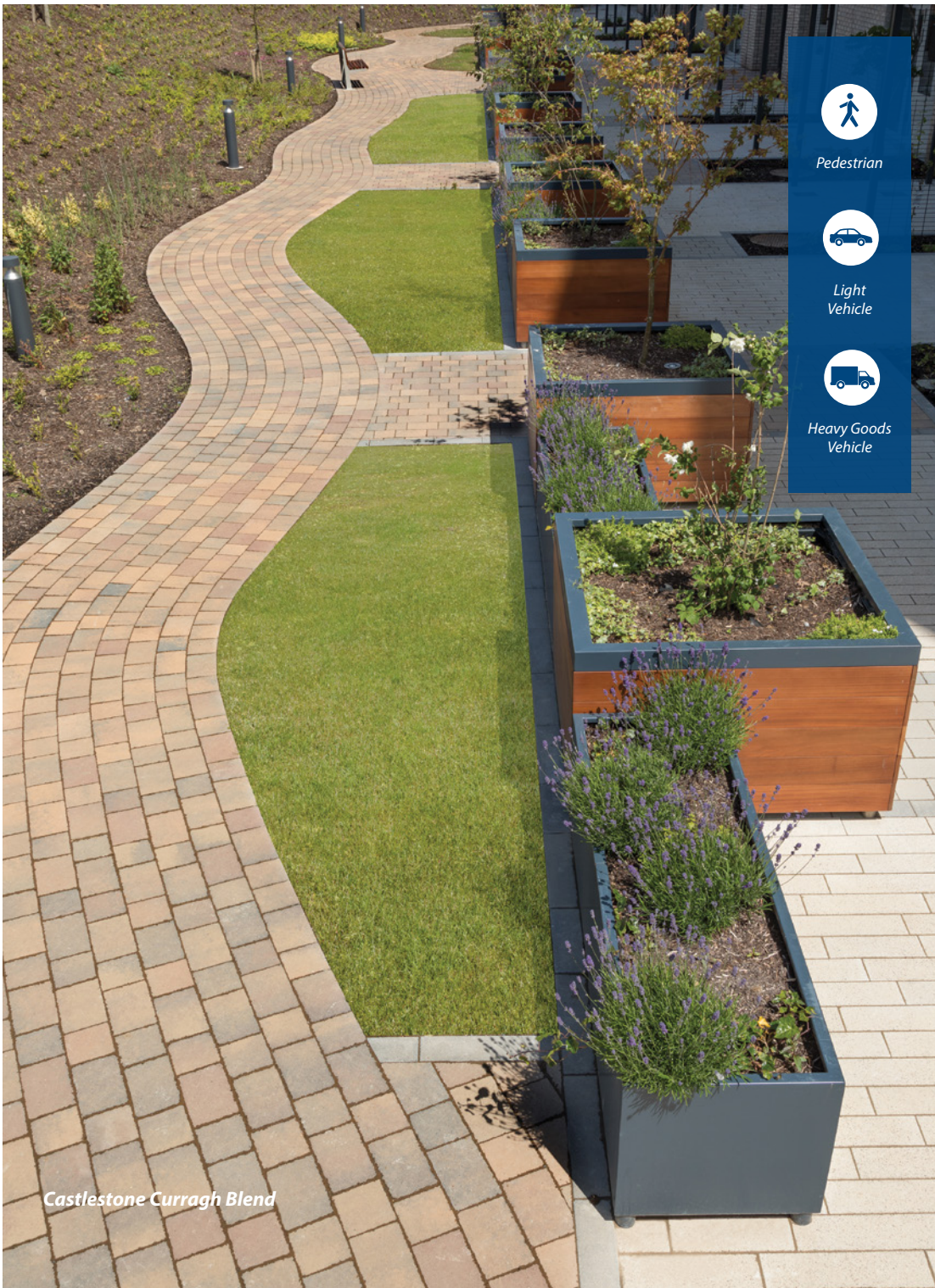

Pedestrian



Light Vehicle



Heavy Goods Vehicle

Castlestone Curragh Blend

CASTLESTONE

Antiqued rustic appearance



Natural



Charcoal Grey



Tan



Curragh Blend



Causeway Blend



Heather



Limestone Blend

Product Sizes & Quantities

Size	Depth	Quantity (per m ²)	Quantity (per bale)	Bale size
240 x 160mm	60mm	26	360	13.82m ²
160 x 160mm	60mm	39	504	12.90m ²
120 x 160mm	60mm	52	672	12.90m ²
240 x 160mm	80mm	26	300	11.52m ²
160 x 160mm	80mm	39	360	9.23m ²
120 x 160mm	80mm	52	672	12.90m ²

Size (Mixed Bale)	Depth	Quantity (per m ²)	Quantity (per bale)	Bale size
160 x 160mm & 240 x 160mm	60mm	15.6 units of each size	432	13.82m ²

Mixed bales include an equal number of all sizes.



Castlestone Natural and Charcoal Grey



Castlestone Causeway Blend



Castlestone Limestone Blend



Castlestone Curragh Blend



 Pedestrian
 Light Vehicle

THOMOND

Chamfered edge defined with sharp clean line



Product Sizes & Quantities

Size (Mixed Bale)	Depth	Quantity (per m ²)	Quantity (per bale)	Bale size
240 x 160mm & 160 x 160mm	60mm	15.6 units of each size	432	13.82m ²

Thomond Vermont



Thomond Harvest Blend



Thomond Natural



URBANA

Paved surface modelled on natural stone



Product Sizes & Quantities

Size (Mixed Bale)	Depth	Quantity (per m ²)	Quantity (per bale)	Bale size
300 x 200mm & 200 x 200mm & 200 X 100mm	60mm	8.33	324	12.96m ²

Mixed bales include an equal number of all sizes.



Urbana Limestone



Urbana Setts Charcoal Grey

URBANASETTS

“T” shaped pieces provide an alternative to laying a sett detail



Typical Format

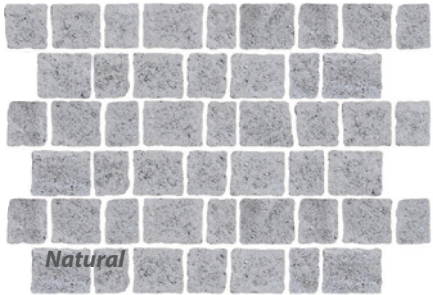

Natural



Charcoal Grey

Product Sizes & Quantities

Size (Mixed Bale)	Depth	Quantity (per m ²)	Quantity (per bale)	Bale size
400/200 x 200mm	60mm	16.67	160	9.6m ²



Urbana Setts Natural and Urbana Sandstone



VERONA PAVING & SETTS

Exposed aggregate granite appearance

Product Sizes & Quantities

Size (Mixed Bale)	Depth	Quantity (per m ²)	Quantity (per bale)	Bale size
240 x 160mm & 160 x 160mm	60mm	15.6 units of each size	432	13.82m ²

Mixed bales include an equal number of all sizes.

Setts Sizes & Quantities

Size	Depth	Quantity (per m ²)	Quantity (per bale)	Bale size
100 x 100mm	60mm	100	1000	10.00m ²

*Verona Paving White Granite
with Midnight border*

Verona Paving



Natural



White Granite



Midnight



Silver Granite

Verona Setts



Natural



White Granite





Midnight



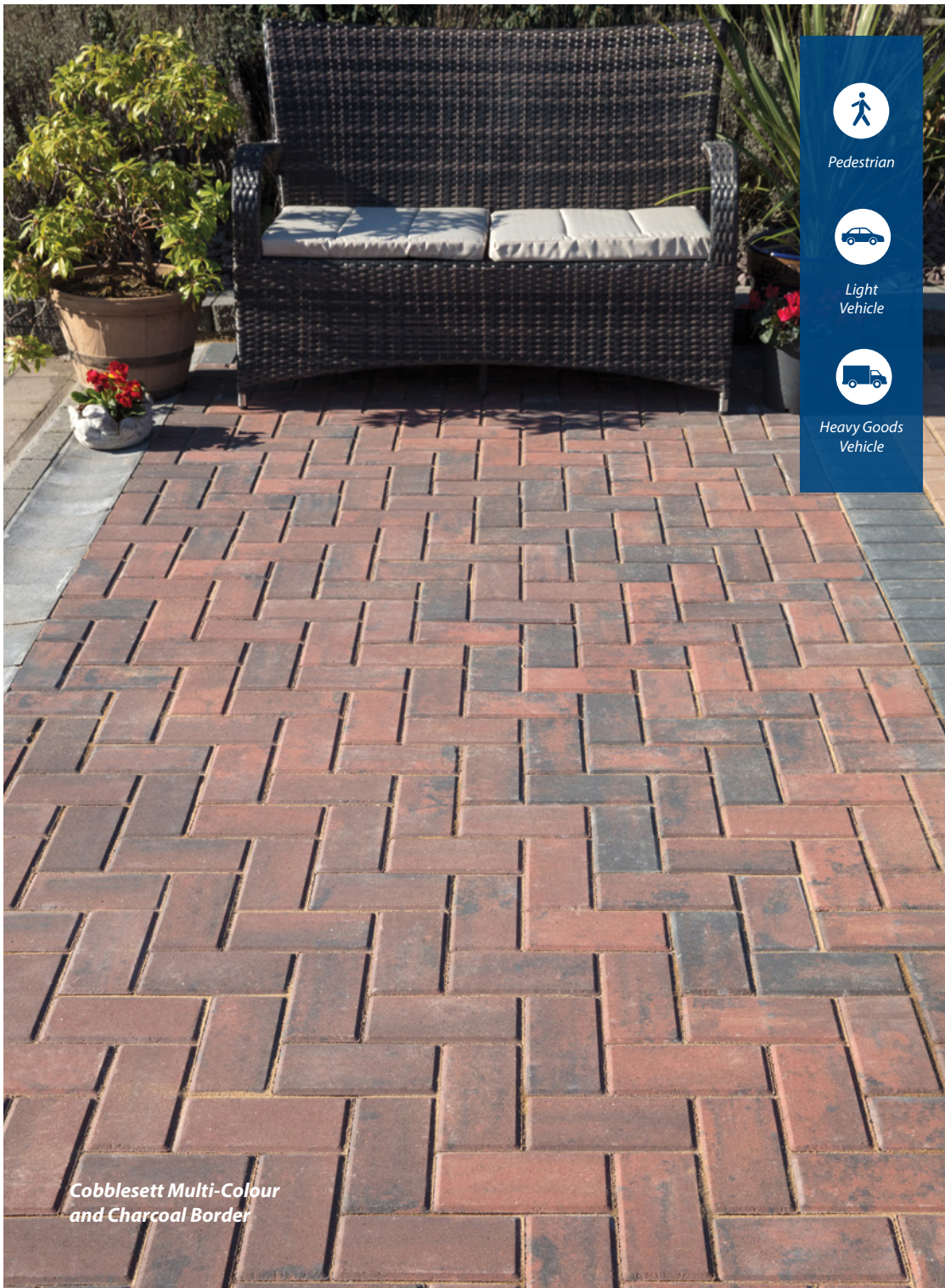

Silver Granite





- 

Pedestrian
- 

Light Vehicle
- 

Heavy Goods Vehicle

COBBLESETT

Rectangular pavior with chamfered top edge

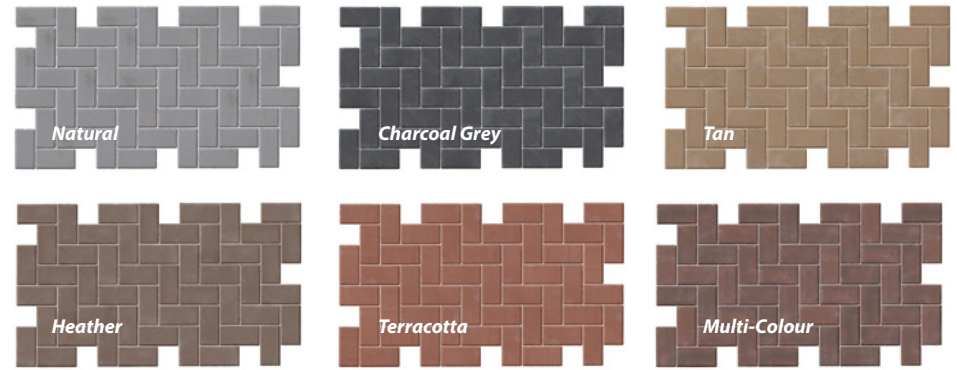

Product Sizes & Quantities

Size	Depth	Quantity (per m ²)	Quantity (per bale)	Bale size
200 x 100mm	60mm	50	600	12.00m ²
200 x 100mm	80mm	50	500	10.00m ²

Cobblesett Multi-Colour and Charcoal Border

CASTLESTONE SETTS



Square setts to enhance all 60mm paving ranges as borders and features.



Product Sizes & Quantities

Size	Depth	Quantity (per m ²)	Quantity (per bale)	Bale size
100 x 100mm	60mm	100	1000	10.00m ²



 Pedestrian
 Light Vehicle

SuDS - SUSTAINABLE URBAN DRAINAGE SYSTEM

A sustainable urban drainage system (SuDS) is an alternative to the traditional pipes, gullies and culverts approach to a development and its drainage strategy. A SuDS system comprises components and techniques that are deemed to be more sustainable and deal with storm water at source.



Sustainable urban drainage systems (SuDS) mimic natural drainage processes by employing these three key principles: water quality, water quantity and biodiversity/amenity.

The Roadstone Aquaflow system provides the means to not only achieve but excel in the three key SuDS principles. Through considerate design, careful selection of techniques and materials, the Roadstone Aquaflow

blocks and the Roadstone Aquaflow system deliver the following benefits:

- **Reducing water quantity** - Dealing with surface water at the source reduces the effects of urbanisation and the impact of localised flooding
- **Improving water quality** - Roadstone Aquaflow provides two levels of storm water treatment: removing harmful pollutants and protecting the environment downstream
- **Contributing to the biodiversity** - Contributing to the biodiversity of development by working in conjunction with other SuDS techniques. Roadstone Aquaflow allows any hard standings, including roads, to be used as drainage, producing a traditional looking surface with many desirable features.

AQUAFLOW PAVING SOLUTION

AQUAFLOW system

Roadstone Aquaflow has used research and design to evolve the Roadstone Aquaflow permeable paving system into one of the most cost effective and functional SuDS within the marketplace.

The Roadstone Aquaflow system has a unique sub-base design incorporating SC Intergrid which reduces construction costs whilst giving superior structural performance. Water quality improvement is realised through the use of our tried and tested Inbitex Geotextile which removes the requirement for downstream pollution control. The patented Roadstone Aquaflow system fits

neatly within any block paving project, where your paving design becomes your drainage design and vice versa.

Roadstone Aquaflow SuDS can be designed as fully attenuation, fully infiltration or as a partial infiltration system. Attenuation (tanked) systems capture storm water to be collected and released in a controlled manner into sewers and downstream watercourses. Infiltration systems allow rainwater to be infiltrated into the ground mimicking a green field environment. Storm water leaving the Roadstone Aquaflow system is cleaned and filtered through

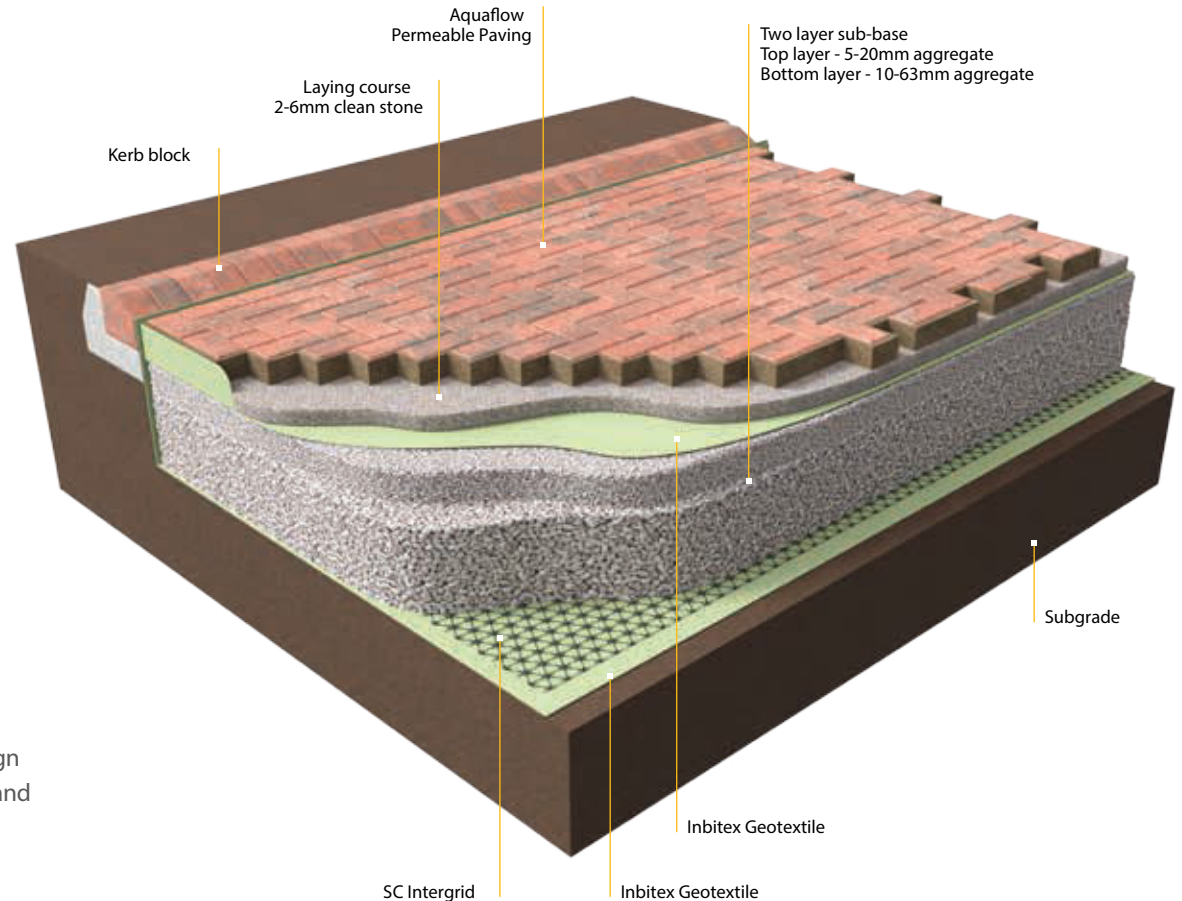

the Inbitex Geotextile layers that promote microbial action. Water quality improvement allows secondary non-potable uses to be carried out such as flushing toilets and watering the garden. The Roadstone Aquaflow system can be designed for use in both trafficked and pedestrianised areas, allowing the collection and treatment of storm water from any paved surface.

Advantages of Roadstone Aquaflow

- Dealing with storm water at source
- Reduces water quantity
- Improves water quality
- Lowers construction costs
- Allows collection of storm water from impermeable surfaces
- Improved maintenance programme.

TYPICAL INFILTRATION SYSTEMS

There are four basic systems designs (see below). Each design can be tailored for infiltration or tanked according to requirements.

Infiltration

The system is underlaid with a pervious geotextile membrane (Inbitex) and is suitable for use where it is proposed to infiltrate the water directly into a suitable sub-grade.

Tanked

The system is underlaid by an impervious plastic membrane (SC membrane) and is suitable for use where it is proposed to attenuate storm water before releasing it in a controlled manner, harvest the water for re-use or where difficult or contaminated sub-grades are encountered.

The type of membrane used and the method of sealing will depend upon the application. In some circumstances, the membrane will require additional protection from puncturing and specialist advice should be obtained.

The impervious membrane restricts water entering the sub-grade and preserves sub-grade structural integrity. This is very important where clay subgrades are encountered.

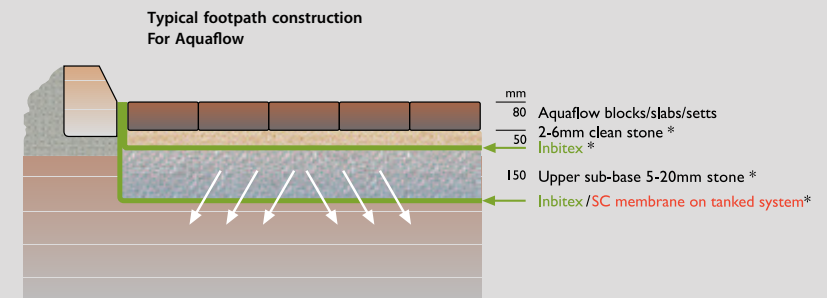
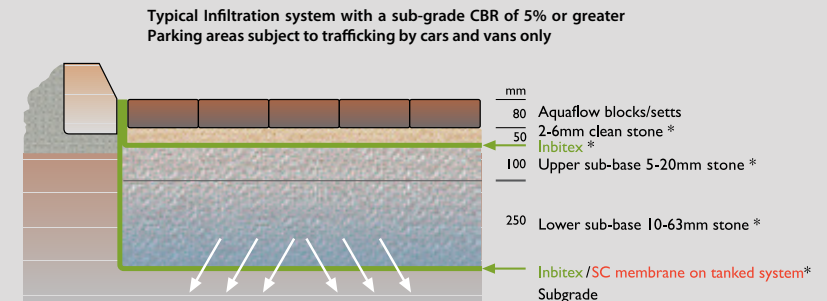
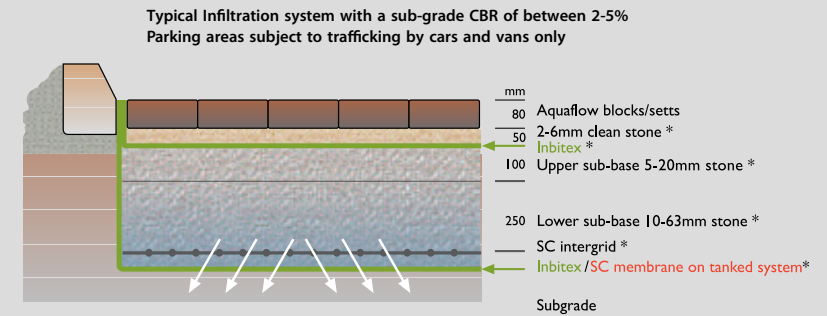
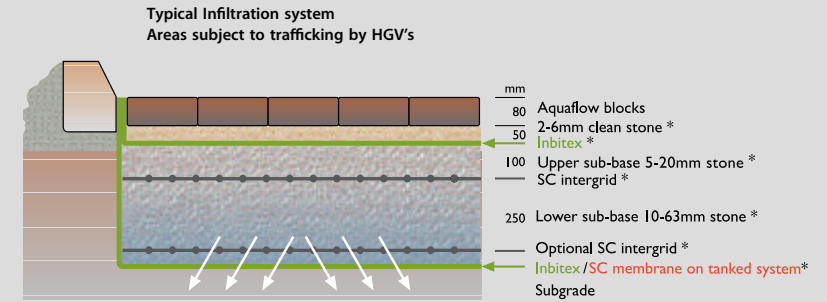

DESIGN SERVICES FROM CONCEPT TO COMPLETION

In conjunction with our permeable paving design consultants Formpave, Roadstone can offer a comprehensive design service to suit individual design requirements.

The team of experienced engineers have designed more than 3,000 permeable paving schemes, both here and in the UK, during the past 20 years.

All designs carried out by the design team are project specific; each individual design is carefully considered and bespoke to the project in mind.

Contact us with your design query

Tel: 01 4041200

Web: www.roadstone.ie

Email: info@roadstone.ie

Design Services

- Validation of permeable paving designs
- Full structural and hydraulic permeable paving designs complete with layout drawings and construction details
- Free technical advice
- Access to a range of typical details
- Value engineering service

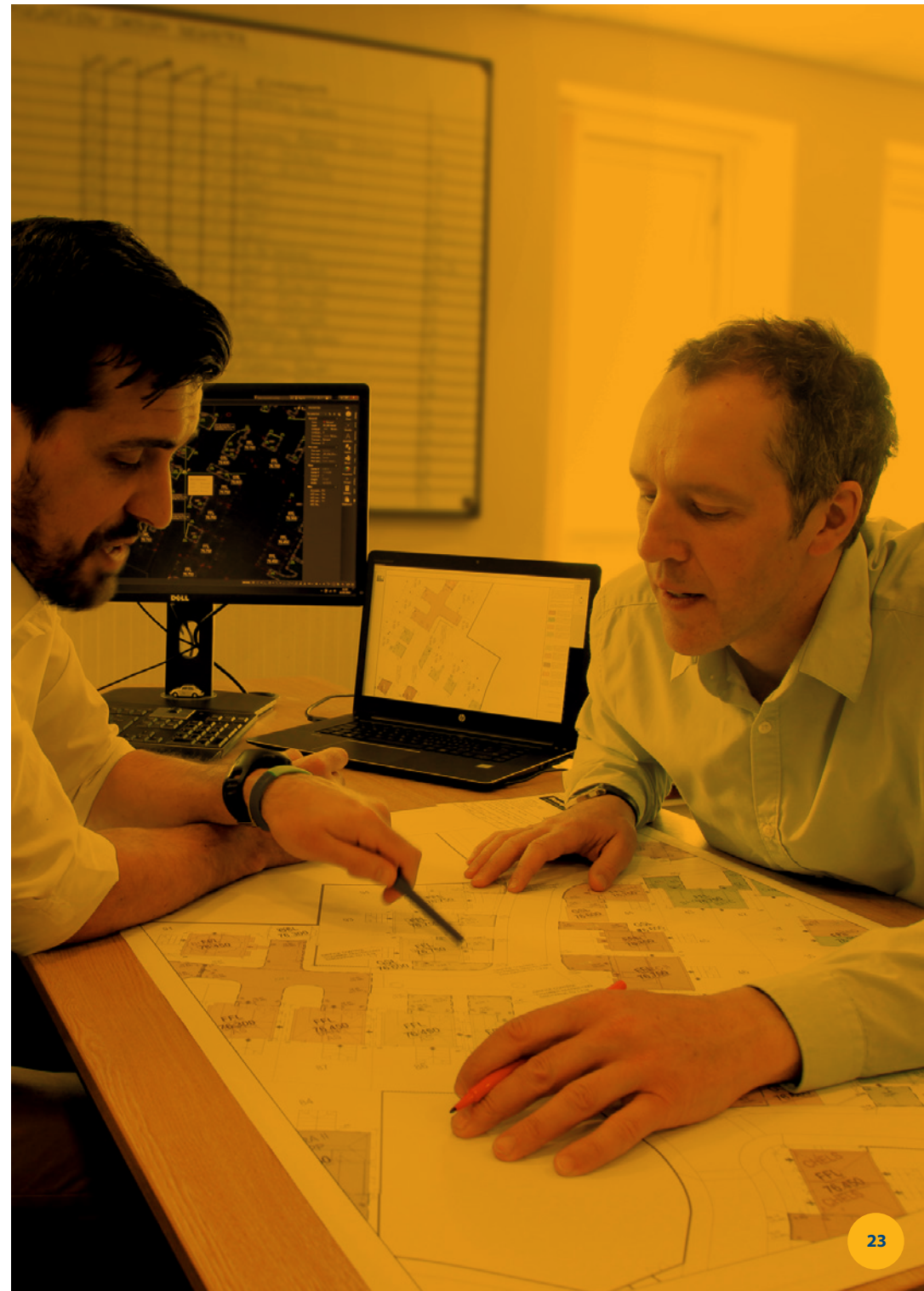



Aqua Castlestone Curragh Blend

AQUA CASTLESTONE

Antiqued rustic appearance

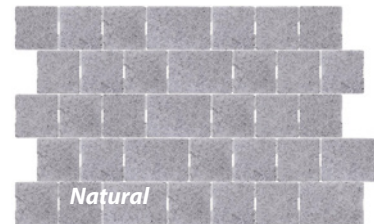



Product Sizes & Quantities

Size (Mixed Bale)	Depth	Quantity (per m ²)	Quantity (per bale)	Bale size
240 x 160mm & 160 x 160mm	60mm	15.6 units of each size	432	13.82m ²



- 

 Pedestrian
- 

 Light Vehicle
- 

 Heavy Goods Vehicle

*Aqua Thomond Harvest Blend
with Charcoal Border*

AQUA THOMOND

Chamfered edge defined with sharp lines

Product Sizes & Quantities

Size (mixed bale)	Depth	Quantity (per m ²)	Quantity (per bale)	Bale size
240 x 160mm & 160 x 160mm	60mm	15.6 units of each size	432	13.82m ²
240 x 160mm	80mm	26	300	11.52m ²

Mixed bales include an equal number of all sizes.



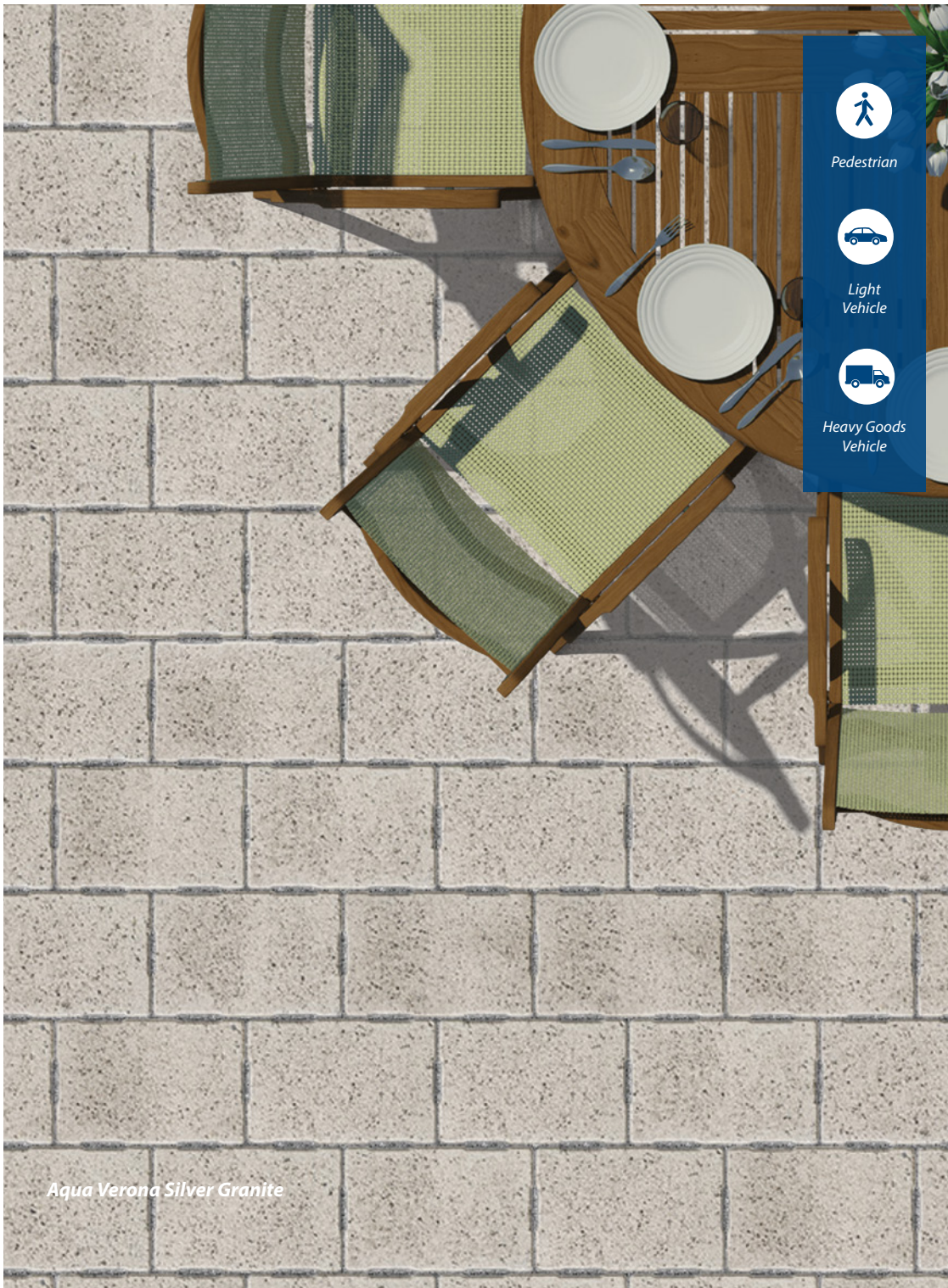

AQUA VERONA

Exposed aggregate granite appearance

Aqua Verona 60mm

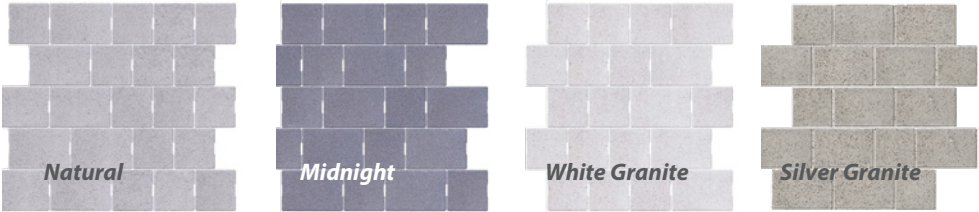

Product Sizes & Quantities

Size (Mixed Bale)	Depth	Quantity (per m ²)	Quantity (per bale)	Bale size
240 x 160mm & 160 x 160mm	60mm	15.6 units of each size	432	13.82m ²

Mixed bales include an equal number of all sizes.

Aqua Verona Single Sized 80mm - Product Sizes & Quantities

Size	Depth	Quantity (per m ²)	Quantity (per bale)	Bale size
240 x 160mm	80mm	26	300	11.52m ²

AQUA RIVEN

Paved surface modelled on natural stone



Aqua Riven Single Sized 80mm

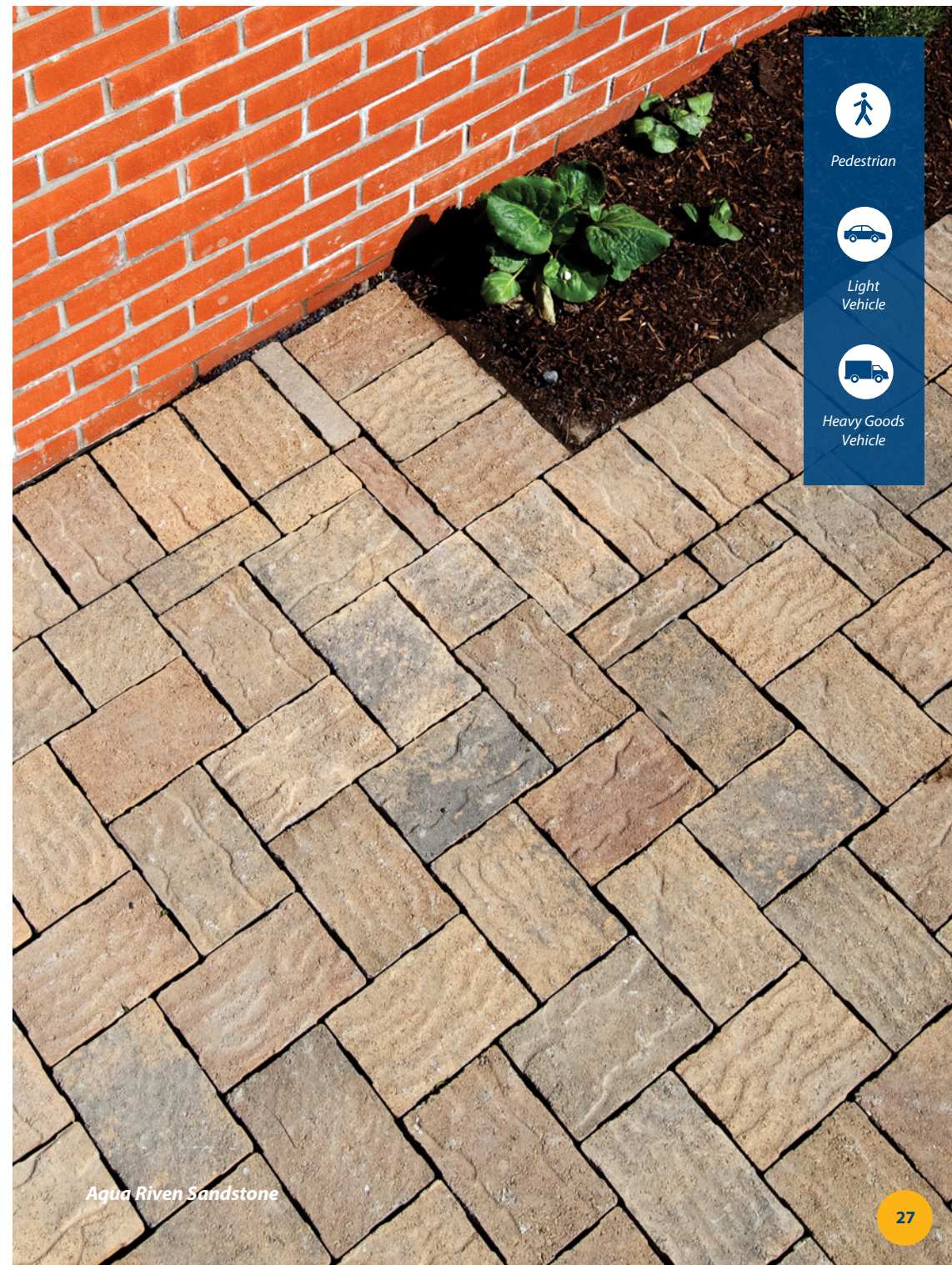

Product Sizes & Quantities

Size	Depth	Quantity (per m ²)	Quantity (per bale)	Bale size
240x160mm	80mm	26	300	11.52m ²



-  Pedestrian
-  Light Vehicle
-  Heavy Goods Vehicle



Pedestrian



Light Vehicle



Heavy Goods Vehicle

Aquaflow ML Natural and
Charcoal Grey with Cobblesett
Charcoal Grey Border

AQUAFLOW ML

Aquaflow ML can be laid by hand or by machine.
Designed for heavy-duty applications

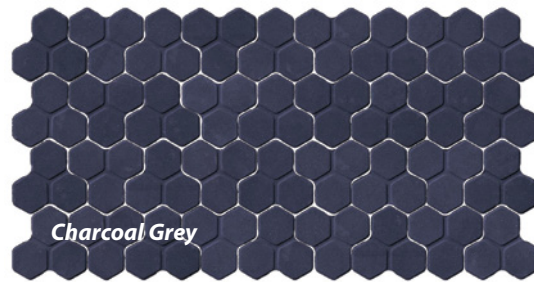
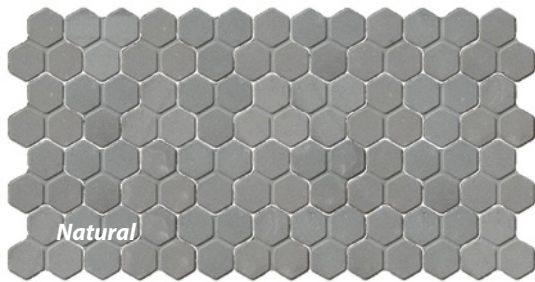

Aquaflow ML

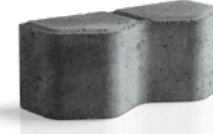

Aquaflow MLTB



Aquaflow MLE

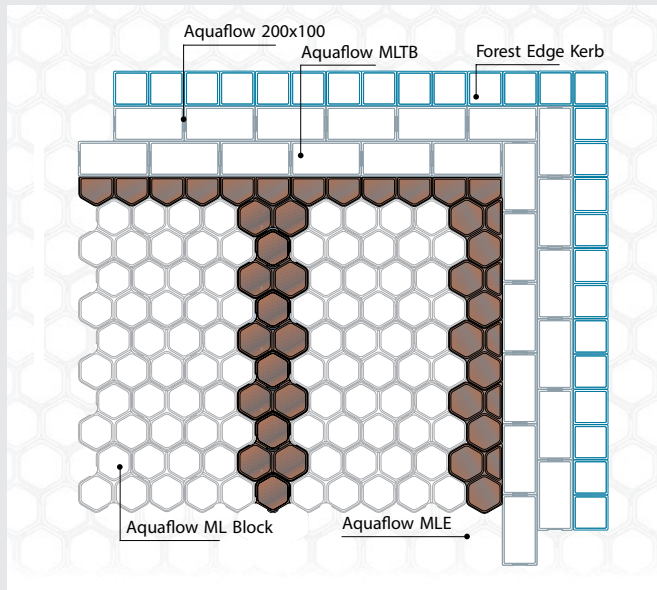

Aquaflow ML block®

For Roads and heavy duty use

Size
80mm

Laying pattern
Include stretcher course around
edge in conjunction with MLE and

MLTB

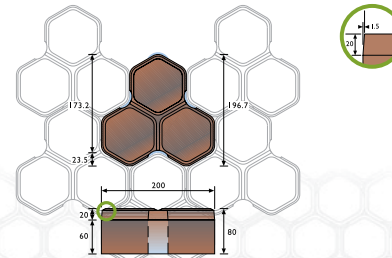

Aquaflow MLE®

Endblock
For use with Aquaflow ML blocks

Size
80mm

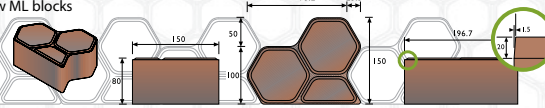

Aquaflow MLTB®

Top and bottom block
For use with Aquaflow ML blocks

Size
80mm

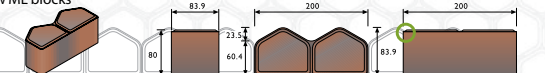



Aqua Cobblesett Natural

-  Pedestrian
-  Light Vehicle
-  Heavy Goods Vehicle

AQUA COBBLESETT

Rectangular pavior with chamfered top edge



Natural



Charcoal Grey



Tan



Heather

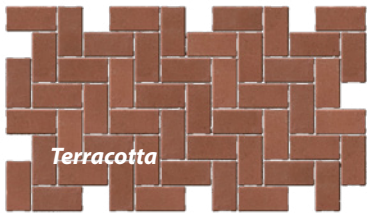

Terracotta



Multi-Colour

Product Sizes & Quantities

Size	Depth	Quantity (per m ²)	Quantity (per bale)	Bale size
200mm X 100mm	80mm	50	500	10.00m ²

STONE SPECIFICATIONS



Lower sub-base layer 10-63mm clean crushed stone	
Sieve sizes	% passing
80mm	90-100
63mm	90-100
40mm	60-80
20mm	15-30
10mm	0-5
Los Angeles Coefficient	LA - 25
Reference specification	I.S. EN 13242 + SR21 Annex B



Laying course 2-6mm clean crushed stone	
Sieve sizes	% passing
10mm	98-100
6.3mm	80-100
2mm	0-100
1mm	0-5
Los Angeles Coefficient	LA - 25
Reference specification	I.S. EN 13242 + SR21 Annex B



Upper sub-base layer 5-20mm clean crushed stone	
Sieve sizes	% passing
40mm	100
20mm	90-100
10mm	25-75
4mm	0-15
2mm	0-5
Los Angeles Coefficient	LA - 25
Reference specification	I.S. EN 13242 + SR21 Annex B
Material specification	Material supplied shall be referred to as 5-20mm clean crushed stone and conform to the above sieve analysis and aggregate testing.



Surface Dressing 2-4mm clean crushed stone	
Sieve sizes	% passing
6.3mm	100
5mm	95-100
3.35mm	66-90
1.18mm	0-20
600 microns	0-8
600 microns	0-1.5
Los Angeles Coefficient	LA - 20
Reference specification	I.S. EN 1097-2 I.S. EN 1097-8 Annex A

*Aggregate Testing

Los Angeles Coefficient (LA) - Determination of resistance to fragmentation = 20 BS EN 13242:2002. Note: Lower values than those specified signifies better resistance to fragmentation and abrasion and is therefore acceptable.

AQUAFLOW COMPONENTS

Inbitex Geotextile

Exclusive to Roadstone/Formpave Aquaflow system, this non-woven geotextile is used for separation, filtration and pollution control.

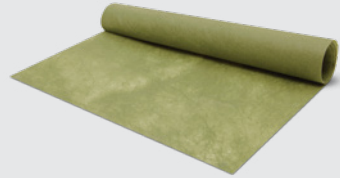

SC Intergrid

Exclusive to Roadstone/Formpave and the Aquaflow system this sub-base stabilisation grid improves structural strength, increases design life and reduces construction costs.

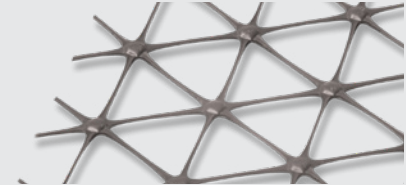

SC Membrane

This impermeable membrane allows the storage of collecting storm water. Used for the Aquaflow attenuation system it can be welded or taped dependent on the application. A higher grade SC Membrane GT can be specified when contamination is present.

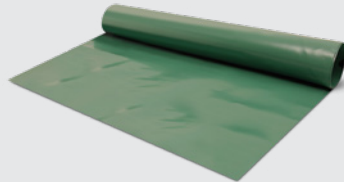

SC Findrain

This drainage component allows efficient and high flow removal of storm water from the Roadstone Aquaflow system. Wrapped in Inbitex Geotextile which provides further filtration and cleansing.



Aquaflow Distribution Tanks

Voided crates that are extremely strong structurally and are wrapped in Inbitex Geotextile, which provides filtration and cleansing. Allows the collection of impermeable surface water catchment, such as roofs to the Aquaflow system.

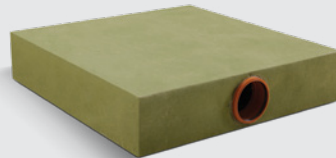

Top Hats, Tape and Fittings

Roadstone Aquaflow system components.

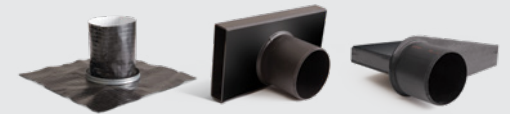

SuDS SPECIFICATION

Types(s) of Paving

Roadstone Aquaflow permeable concrete block paving range.

Reference

Roadstone Aquaflow paving.

Size

As per Roadstone Ltd.

Colours

Various colours and finishes available.

Setting Out

See page 47/48 of brochure.

Kerbs

See page 30-32.

Laying course

50mm depth of 2-6mm single size clean crushed stone to I.S. EN 13242 +SR 21 Annex B. The crushed stone used for the laying course must have a minimum LA Coefficient of 25.

Inbitex Geotextile

As specification.

Depth of Sub-base

It is recommended that a sub-base depth of 350mm should be used. The depth of sub-base may be varied at the discretion of the engineer.

Sub-base Specification

All granular sub-base material shall comprise crushed rock or concrete possessing well defined edges. It must be sound, clean, non-friable and free from clay or other deleterious matter.

The material must be non-plastic when tested in accordance with BS1377 Test No.4.

The crushed stone used for the sub-base must have a minimum LA Coefficient of 25.

The selected test samples shall not be oven dried and should be soaked in water at room temperature for 48 hours before the test. The 100mm deep upper layer of sub-base material should be graded 5mm-20mm to I.S. EN 13242 +SR 21 Annex B.

Intergrid(s)

SC Intergrid Geogrid.

DBM Running Course

To be 20mm dense base binder course manufactured with 100/150 grade bitumen to BS4987. The DBM shall conform with the Requirements of BS 4987.

SC Membrane Geomembrane

Generally a taped membrane will be suitable for most applications of the tanked system. If a guaranteed watertight system is required a fully welded system should be installed.

Examples of this type of application would be sites with a high water table, methane contamination, areas above basements or retaining walls. Further advice should be sought from the Formpave design team.

Findrain

150/300mm Findrain to BBA Number 95/85.

Top hat seal

Formpave top hat seal.

PERMEABLE BLOCK PAVING MAINTENANCE GUIDE



Operation & maintenance requirements

Maintenance schedule	Action	Frequency
Monitoring	Initial inspection	Within 3 months
	Inspection for poor performance and silting	Annually
	Inspect ancillary drainage components i.e. gullies, outfall pipes etc.	Annually
	Establish if re-gritting is required.	Annually
Regular maintenance	Sweeping surface to remove debris and contamination	1-2 times a year, typically Spring and after leaf fall in Autumn
Regular Maintenance (large permeable areas)	For large permeable areas where a mechanical sweeper is to be used, it is mandatory that suction is not applied as this will remove the 2-4mm gritstone	1 - 2 times per year, typically Spring and after leaf fall in Autumn.
Occasional maintenance	Removal of leaves	As required
	Re-gritting using 2-4mm gritstone	As required
Remedial actions	Remediate areas of rutting and depressions	As required
	Replace broken/damaged blocks	As required
	Rehabilitate surface with sweeping and reapplication of 2-4mm clean gritstone	As required

SPLAYED KERB BLOCK

Three-way kerb block provides options for Bull Nose, Low Splay, or a High Splay Kerb

Splayed Kerb Block

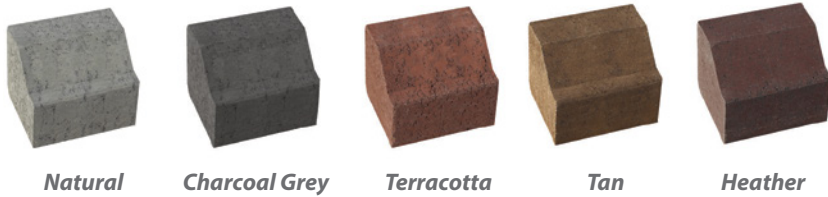

Mini Splayed Kerb Block



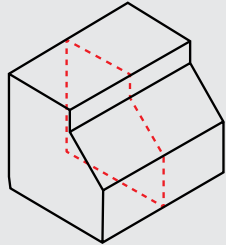

High Splay
Ideally used where more restraint and a higher definition is required.

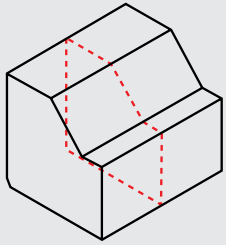

Low Splay
Ideally used where access is required.

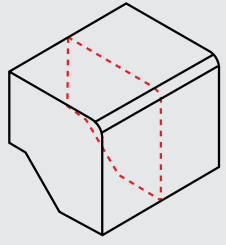

Bull Nose
Perfect for steps and for a softer edge appearance.

Size	No. per L/Meter
200 x 160 x 160mm	5
100 x 160 x 160mm Mini Kerb	10



CASTLESTONE KERB

Multi-purpose kerb



Natural



Charcoal Grey

All Kerb Blocks should be laid in accordance with BS 7533.

Size L x W x H	No. per L/Meter
240 x 120 x 160mm	4.16
240 x 160 x 120mm	4.16
160 x 120 x 240mm	6.25
120 x 160 x 240mm	8.33

VERONA KERB

This kerb is a shot-blasted creating the granite effect. Ideal for use with the Verona range or any of our other products. The Verona Kerb is available in silver grey and is ideal for the home or commercial applications.

All Kerb Blocks should be laid in accordance with BS 7533.



	Size	No Per Linear Metre	Weight
Bullnose Edge	200 x 100 x 915mm	1.01	46 kg

HALF BATTERED KERB

HB2 Kerb

The Half Battered (HB2) Kerb is ideal for commercial use. The fine textured and smooth surface allows the HB Kerbs to be used as a finished product. They are ideally suited for commercial roads, industrial and residential estates and in domestic situations where large areas of kerbing need to be carried out at an economical rate.

As with all of the Roadstone Kerb block range, the applications of use are not restricted to paving only. Any of our Kerb blocks can be used for a variety of different applications – from concrete pathways to edge detailing on your driveway, to creating a designed area for planting or decorative aggregates.

Size	No. per L/Meter	Unit Weight
915 x 255 x 125mm	1.01	66 kg
915x175x125mm (Bale size: 16.47)	1.01	



CHANNEL BLOCK



Natural



Charcoal Grey



Terracotta



Tan

When designing the falls across paving, it is necessary to look at the path that the surface water will follow.

Roadstone's Channel block is the solution. With the coordinating face size of 200 x 200mm and a depth of 70mm, it is ideal to meet your needs.

The 10mm deep dish in the face of the channel block is sufficient to carry the water to the drainage point without creating a trip hazard. As the Channel block is available in standard colours, there is a colour to blend or contrast with your design requirements.

Size	No. per L/Meter	Unit Weight
200 x 200 x 70mm	5	6.5 kg

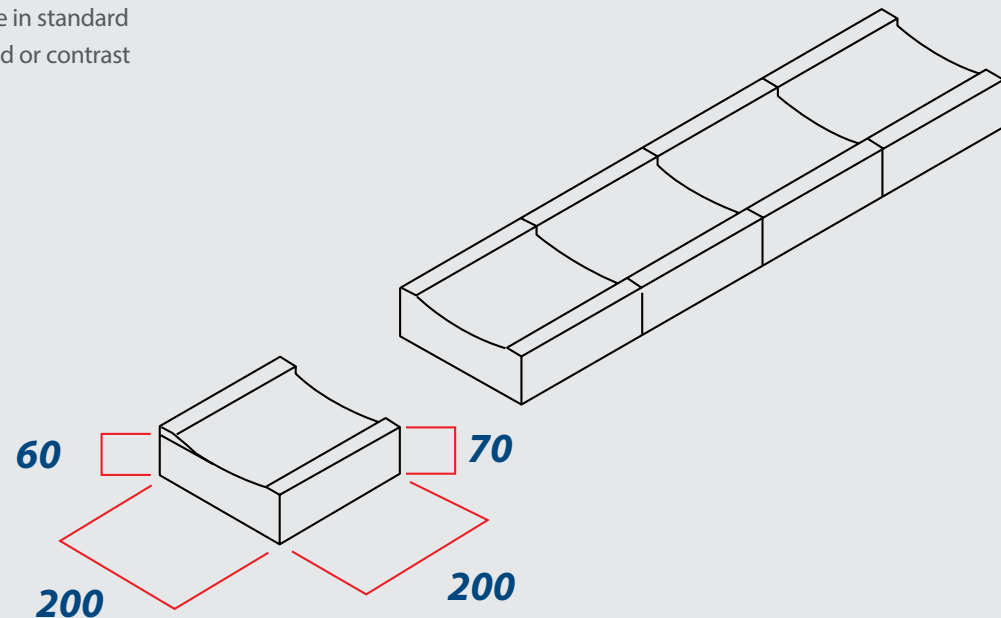

PLAIN FLAGS

Smooth finished surface with a chamfered edge

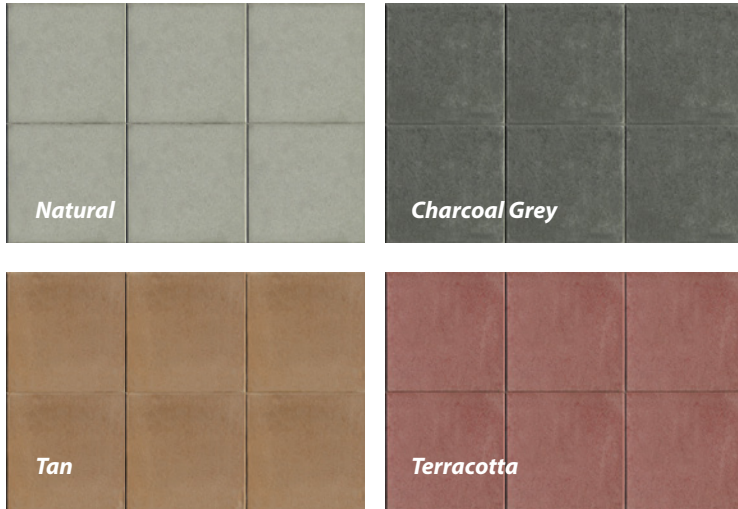

All paving flags should be laid in accordance with BS 7533. Currently this does not allow for the laying of any paving flags on risers or shims.

Size	Depth
400 x 400mm	40mm
400 x 400mm	50mm
600 x 600mm	40mm
600 x 600mm	50mm



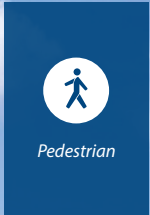

SABLÉ FLAGS

Exposed aggregate granite appearance

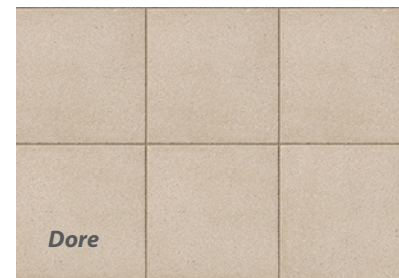

Diana & Klio

Size	Depth	Quantity (per m ²)	Product available
400 X 400mm	40mm	6.25	Diana, Klio, Dore
*600 X 400mm	40mm	4.18	Dore
*600 X 600mm	30mm	2.78	Diana, Klio, Dore

*Available as special order

HAZARD TACTILE WARNING FLAGS

Tactile paving (Blister and Corduroy) are used to convey information to visually impaired pedestrians about their environment.

Manufactured in accordance with BS 7997:2003, and colour coded to meet the products applications, Roadstone's Hazard Warning flags combine functionality with design.

This information provided is intended for guidance only. To ensure that the correct Hazard Warning product and procedures are used refer to BS 7997:2003.



Blister Tactile Flags

The Tactile surface provides a warning to the visually impaired, in the absence of a kerb up-stand at controlled and un-controlled crossings.

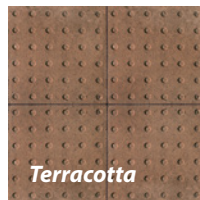

- Required for all public access areas
- Manufactured and designed with a raised dome profile
- Terracotta (Red) at controlled crossings
- Tan at un-controlled crossings

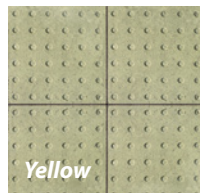

Corduroy Hazard Flags

The Roadstone Corduroy Hazard tactile flag surface conveys the message "Hazard proceed with caution". They are used to provide a warning to visually impaired people of the presence of specific hazards (steps, level crossings etc.) and where a footpath joins a segregated shared route on the cyclist side.

- A warning requirement for all public access areas
- Manufactured and designed comprising of raised rounded bars, transversely across the surface of the flag
- Any colour other than Terracotta (Red).

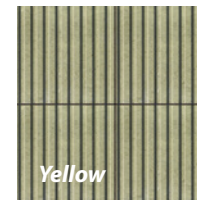

Colour	400 x 400 x 50mm
Tactile Terracotta	✓
Tactile Tan	✓
Cordory Terracotta	✓
Cordory Buff	✓

JOINTING SANDS, COMPOUNDS & SEALANTS

Getting the appropriate jointing sand is almost as important as selecting the paving itself.

Jointing sand is used to fill the joints between the paving and to enhance the interlock between the paving bricks. Weathering and time will almost “seal” the joints, reducing the amount of moisture reaching the sub-base.

Roadstone has developed a kiln dried jointing sand, to specification, to ensure that the joints are filled completely when properly applied.



Jointing Sand

Ideal for any regular paving application. This sand is available from Roadstone in 25kg bags.

Application

Ensure that any surfaces, that the jointing sands are to be applied to, are fully dry. Brush the sand into the joints and then vibrate in if you are laying new paving. If reinstating existing sand, just brush the sand fully into the dry joints.



Joining Compounds

An alternative to traditional mortar joints typically used with natural stone paving. Roadstone Retail provides a range of easy-to-use, self-stabilising jointing compounds. Joints up to 25mm can be easily filled and can provide a more effective approach to the traditional mortar system.

Please contact our experienced staff for further advice and always follow the manufacturer’s recommendations.



Cleaning and Sealant Agents

Protecting your finished paving is as important as maintenance. Roadstone Retail locations offer a range of easy-to-use cleaning and sealing agents for all paved surfaces. Cleaning agents may be required to remove any existing surface dirt. Sealants are then used to protect against dirt, grime and stains.

Please contact our experienced staff for further advice and always follow the manufacturer’s recommendations.

Other Accessories

Roadstone doesn’t just supply paving products. Our retail locations are designed to supply all your paving and building needs. From various sub-base materials and paving sands, to bags of cement and mortar, for collection or delivery.

Visit www.roadstone.ie or contact your local Roadstone Retail Outlets.

RECESSED MANHOLE COVERS

Manhole covers are an essential ingredient of any paving layout as they provide vital access to underlying services and must be clearly identifiable within your garden or driveway design.

From Urbana Paving to Cobblesett, all of the Roadstone Paving range can be laid within the manhole cover to provide continuity of colour, texture and pattern.

Various sizes and strengths are available (contact local retail shop for more details).



ROADSTONE COOL PAVING

Roadstone offers a range of Cool Paving solutions to suit most projects. The use of Cool Paving offers numerous benefits:

- Heat island reduction
- Improved health and comfort
- Improved water and air quality
- Reduced air-conditioning
- Reduced street lighting
- Reduced emissions

Solar Reflectance Index values are now available for our paving range to meet LEED requirements. The Roadstone Aquaflow permeable paving system is also beneficial for Cool Paving projects.

LEED

Leadership in Energy and Environmental Design (LEED) is the most widely used green building rating system in the world. LEED provides a framework to create healthy, highly efficient and cost-saving green buildings. LEED certification is a globally recognized symbol of sustainability achievement.

Heat Island

A heat island is a developed urban area that is significantly warmer than the surrounding undeveloped rural areas due to human activities. Heat islands can negatively impact energy consumption, human health and comfort, water quality and wildlife habitats. Heat island reduction is an important aim of LEED projects and LEED points are available for it.

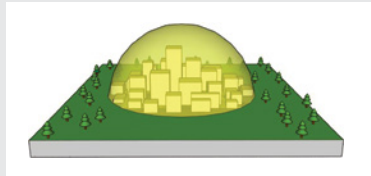

SRI

Solar Reflectance Index (SRI) is a key metric for the contribution of individual construction materials to urban heat islands. SRI is a measure of a surface's ability to stay cool in the sun by reflecting solar radiation and emitting thermal radiation. It is defined such that a black surface has an SRI of 0 and a white surface has an SRI of 100. SRI is calculated by testing a material's solar reflectance and thermal emittance and combining the results in accordance with ASTM E 1980. For heat island reduction higher SRI values are preferable.

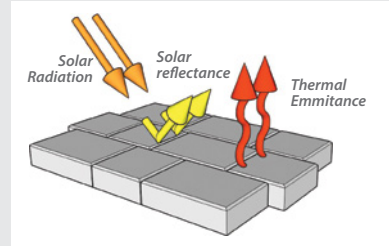

ROADSTONE SRI

Roadstone's complete range of paving colours has now been tested for SRI. Testing was conducted by Atlas Material Testing Technology, USA. See the results in the table below.

Colour	Solar Reflectance (%)	SRI
Charcoal	7.4	5
Midnight	12.1	10
Heather	14.6	13
Terracotta	18.4	18
Tan	20.4	20
Natural	20.8	21
Straw Yellow*	31.6	35
White Granite*	34.4	38
Silver Granite*	38.3	43

*Meets minimum SRI requirements

Cool permeable paving

Unlike a 'Cool Roof', Cool Pavement has no standard definition. In the past emphasis has been placed on reflective paving due to the extensive research carried out on reflective roofs. However research has shown that permeable paving can also have a cooling effect. Many practitioners have therefore expanded the definition of Cool Pavements to include permeable paving.

Unlike traditional paving which is intended to form a relatively water tight surface, permeable paving intentionally permits water to infiltrate the paving and sub-base. From there it is either filtered through a geotextile membrane and in to the subgrade or attenuated on an impervious SC membrane and released in a controlled manner. This water stored within the system can then evaporate through capillary action as the paving heats up, thus cool the paving. This can have a beneficial effect on the paving's contribution towards urban heat islands.

SAMPLE PAVING LAYOUTS

Milan Mixed Stretcher Bond

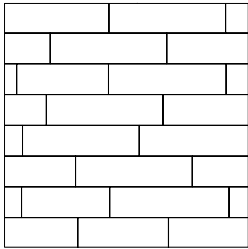

Castlestone & Setts

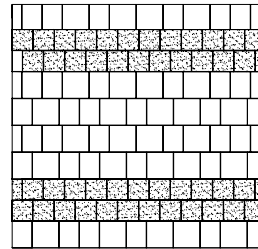

Castlestone mix of 3 sizes

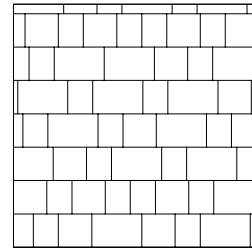

Castlestone mixed stretcher bond

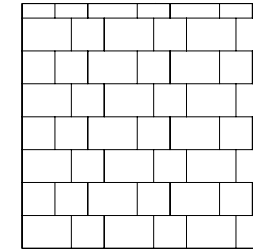

Indicative layouts shown represent a portion of a paved area but should not be used as a pattern to follow or continually repeat, as this may result in having a surplus of one particular size left over. Use all the paving sizes within each bale to cover the required paved area.

Castlestone 45° Herringbone

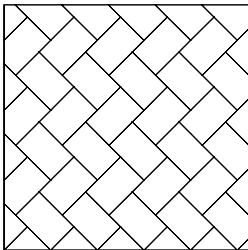

Thomond random bond

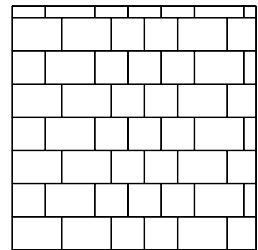

Urbana coursed

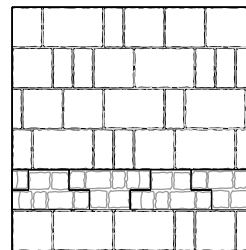

Urbana random

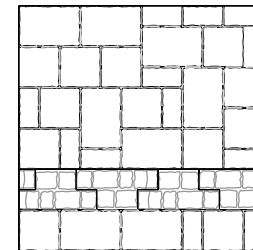

Urbana setts

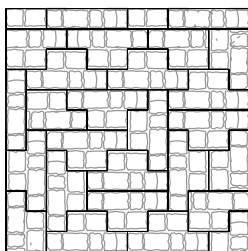

Cobblesett 90° Herringbone

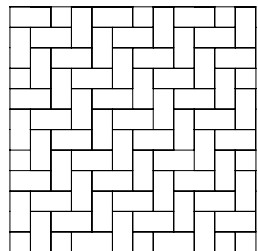

Cobblesett stretcher bond

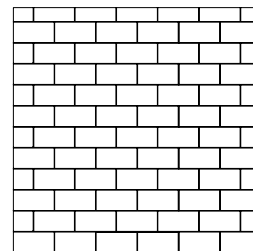

Cobblesett paving

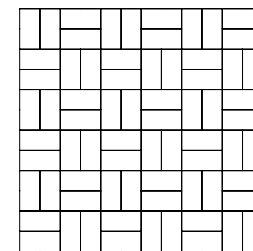

GENERAL INFORMATION - MAINTENANCE

Cleaning & sealing of concrete paving units

All surfaces require some element of cleaning and maintenance, and paving is no different. Regular maintenance and cleaning will maintain the surface appearance and overall performance of both concrete paving and concrete paving flags.

Initial maintenance

During the very early life of the paving, the joints between the units should be regularly "topped up" with jointing sand. The paving should only be brushed by hand. Mechanical sweepers and sweepers with high suction forces should not be used, since there is a risk of loss of jointing sand from between the units which will cause the loss of interlock and failure of the paved surface.

Cleaning of pavements

There are four levels of cleaning that can be carried out on a paved area.

Prior to undertaking any maintenance/cleaning, it is advisable to carry out a trial in a small inconspicuous area to ensure there are no adverse effects on the paving.

1. General dirt should be removed by regular dry brushing.
2. Where the paving has become dull showing a loss of colour, a wet wash with a stiff bristle brush and garden hose can be adequate.
3. For more stubborn areas, a power washer can be used, taking care not to remove the jointing materials (sand or mortar). The washer should be on a medium pressure setting or lower, and should NOT be aimed directly at the paving surface, but at an angle of 30° approximately.
4. Cleaning detergents can be used, however, some detergents are acidic and overuse can damage some paving products. It is advisable to follow the manufacturer's instructions and rinse the areas

fully. The resulting runoff should be carefully channelled to either drainage points or containers from where it can be safely disposed of.

Replace any washed out jointing sand with new dried sand (available in 25 kg bags from Roadstone) once the paving has dried.

Weeds

Avoid the re-occurrence of weeds by removing them once they appear. If a weed killer is required, test in a small area prior to use. Always follow the manufacturer's instructions.

Mosses & Lichens

Mosses and lichens will grow on most surfaces, particularly in shaded and north facing areas. There are several treatments that will deal with these growths on the market. The use of sulphate of iron is not recommended as it will stain the paving.

Efflorescence

This is a naturally occurring phenomenon, which occurs to a varying extent on all cement/ lime based products, for which Roadstone cannot be held responsible. Efflorescence is not a manufacturing fault and in no way affects the structural integrity of concrete products.

Efflorescence, also known as lime bloom, can appear as a white deposit covering part or the entire surface. Except in very severe cases, the phenomenon disappears completely when the blocks are wet and reappears as the blocks dry out. The phenomenon is temporary and will, with time, disappear as a result of normal traffic and weathering.

Efflorescence can be removed using an acidic washing agent. The area should first be thoroughly soaked with clean water and a commercial acidic washing material (available from Roadstone and most builders' merchants) should be immediately applied in accordance with the manufacturer's instructions.

To avoid colour variation of the washed surface, equal amounts of washing agent should be applied to all areas of the pavement.

As the efflorescence dissolves, there will be some frothing (effervescence) and once this has finished the whole surface should be rinsed thoroughly with clean water, taking care to dispose of the run-off safely. In some cases, more than one treatment may be required.

Oil stains

Oil penetrates readily into most concrete paving, therefore any spillages should be removed promptly with an absorbent material, e.g. paper towels, cloth or granules to prevent staining.

DO NOT wipe the oil - this drives it into the concrete and spreads the spill over a larger area.

A degreaser should be applied as soon as possible to break down the oil. Washing up liquid used neat is a good starting point while a suitable degreaser is being sourced. If the stain persists, then an emulsifying degreaser should be brushed onto the affected area, and left for a period of time, in accordance with the manufacturer's instructions. The emulsified oil should be washed away with plenty of water. (Degreasers are available from your local Roadstone outlet and hardware stores)

Sealing

The use of certain sealers can prevent most stains occurring on the surface and aids cleaning. Sealants may require further applications depending on the frequency of use on the paved surface. Where the surface has been treated with a specialist prepolymer urethane sealer and stabiliser, it should be cured in accordance with the manufacturer's recommendations before allowing trafficking.

Permeable Paving Maintenance (Roadstone Aquaflow)

The surface blocks have a design life equivalent to standard block paving. The surface blocks require routine maintenance and the surface should be brushed at least twice a year, either with a mechanical brush, ensuring that the vacuum is switched off, or by hand. It is recommended that this should be carried out in the spring and after leaf fall in autumn.

After the brushing, the 3mm grit should be re-applied to the surface where appropriate (available from Roadstone) and brushed back into the joints.

HEALTH & SAFETY

- Always wear the recommended protective clothing.
- Always work in a well ventilated area.
- When using detergents and cleaners please ensure that you follow the manufacturer's instructions fully.

NOTE:

Prior to undertaking any maintenance/cleaning, it is advisable to carry out a trial in a small inconspicuous area to ensure there are no adverse effects on the paving.

This advice is offered as a guide only; Roadstone does not accept any liability for any damages occurring from its use.

For further details please visit www.roadstone.ie

Roadstone, with its product ranges, has always kept both the customer and the paving contractor at the forefront of its product range, offering both durable and pleasing products along with the correct accessories required to complete any project undertaken.

When considering the physical work and skills required in laying paving, you should include the following:

1. Do you have the required skill and the time to completely finish the job?
2. Have you access to the required tools?
3. Are you fit enough to carry out the physical work required?

If the answer is no to any of the above questions, you should seek the help of an experienced contractor.

The following advice consists general recommendations only, and represent standard good building practise.

Further more detailed information can be obtained from www.roadstone.ie or consult guidance document BS 7533 Parts 1 to 9.

Site Preparation

- Remove all site vegetation and top soil to a suitable load bearing stratum, incorporating the correct level, including falls. Check and remove any soft spots and fill with appropriate material.

Sub Base Construction (typical residential application)

- Typically a sub-base of compacted Clause 804 or similar, between 150mm and 300mm deep will be sufficient for most applications, depending on soil type, depth of build-up required and loading that will be applied to the finished surface.
- For footpaths around dwellings, material conforming to Annex E of SR21:2004+A1:2007 "guidance on the use of I.S. EN 13242:2002 – Aggregates for Unbound and Hydraulically Bound Materials for use in Civil Engineering Work and Road Construction (incorporating amendment 1:2007 --- (4/40mm coarse aggregate, or suitable Clause 804 material).
- The sub-base should be compacted using a vibrator or roller to within 10/15mm of level required. (40mm + depth of paving unit below finished level).
- Falls should be built into the sub-base and the area should be free draining. A saturated sub-base and laying course is one of the main causes of failure and rutting.
- Before spreading the laying paving grit sand, the area should be inspected and no area of the finished level of the base course should be more than the depth of the block +40mm, especially around manholes, kerbing and other obstacles.

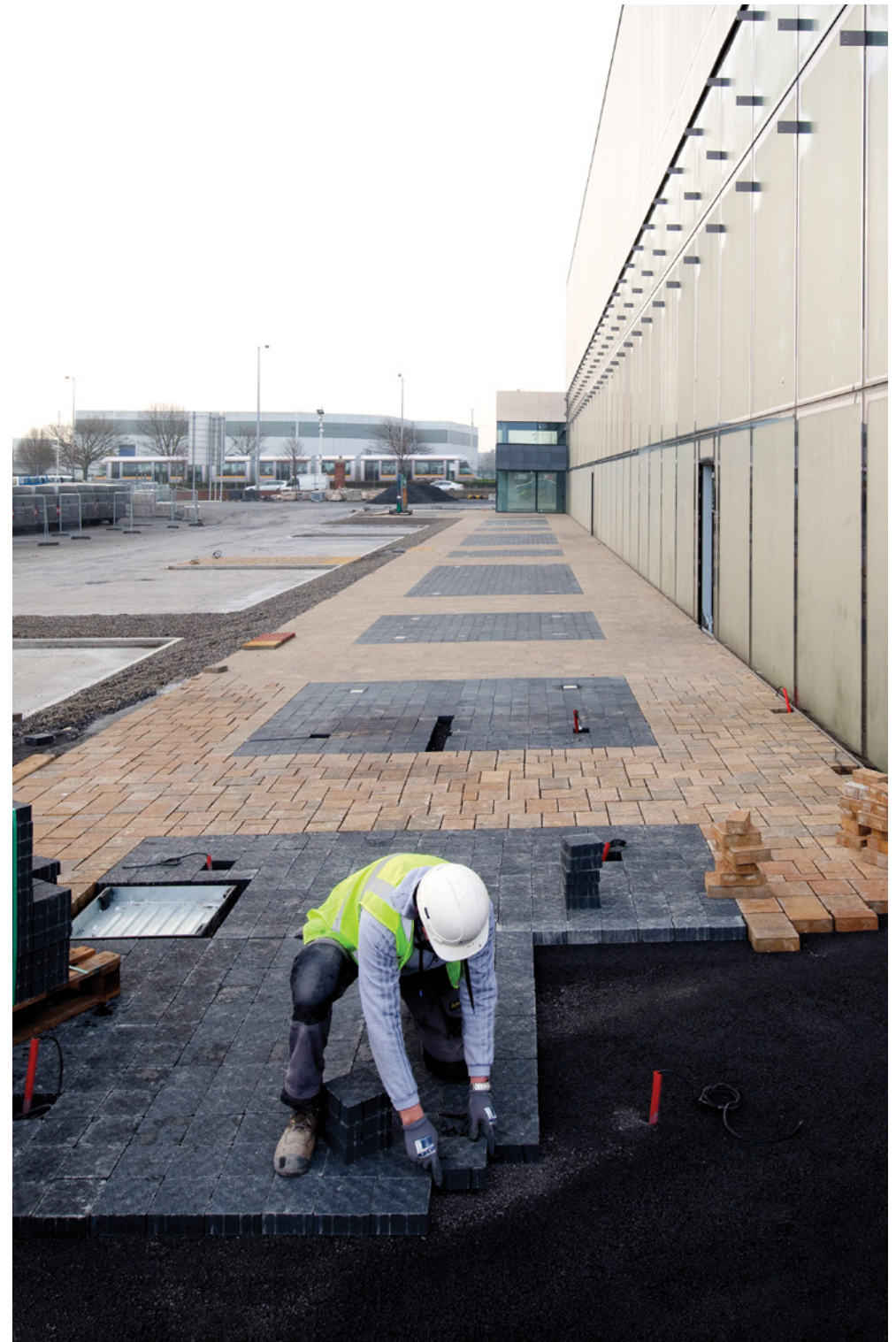

Edge restraints

- A selection of concrete kerbs and edge restraints including Edge Pro are available from Roadstone.
- Generally concrete kerbs are used, kerbs should be fixed into position by haunching the kerb unit with a suitable concrete mix.
- Ensure kerb line follows the fall of the finished surface.

Screeding of Bedding

- The laying course should be a washed course grit sand complying with the requirements of Tables D1 & D2 of annex D of BS 7533 Part 3. Available from Roadstone locations.
- This should be 40mm in thickness after final compaction.
- Pay particular attention to the setting of the bedding course, as the finished surface of the paving will mirror this layer. Ensure correct falls are maintained. Use screeding rails to ensure a correct surface level.

- This can be laid either partial pre-compaction or compacted after laying.
- Do not walk on surface after screeding / laying sand.

Laying of Paving

- Decide on required pattern and work from a corner.
- Always lay the paving against any falls (up hill).
- Work across the paved surface.
- Check lines and levels regularly.
- Cutting of paving should be carried out using a block splitter (guillotine) – please ensure that you follow the manufacturer's guidelines for use.
- **Always select products from at least three different bales to ensure a correct blending is achieved.**
- A concrete saw can also be used, but care should be taken not to allow dust from this saw onto the

finish surface or the blocks prior to use. Cutting with a con saw should therefore be carried out away from the work area and the cut block cleaned before placing.

- After cutting in and laying all blocks, check surface and remove and replace any damaged or defective blocks.
- Sweep all debris material from the area and carry out a final check for damaged or defective blocks.
- Do not lay paving on saturated sand as the laying course will be unstable and liable to rutting until the sand dries out.

Plate Vibrating, Interlock and Joint Filling

- Use a suitable weight vibrator.
- Ensure the surface of the vibration plate is clean.
- Some vibrators can be fitted with a rubber mat that will reduce the possibility of scuffing the surface of the block.
- The Initial pass with a plate vibrator should compact the blocks approximately 20/25% into the sub-base, bringing the sub-

IMPORTANT

Every care has been taken to reproduce the colour and blocks in this document as accurately as possible. However, we can not reproduce exact colours in print and recommend you examine relevant samples prior to ordering.

Roadstone is not responsible for the naturally occurring phenomenon of efflorescence nor the normal variation in colour or texture inherent in concrete products.

The information given in this brochure is correct to the best of our knowledge but customers and specifiers must satisfy themselves as to the suitability of any particular product, specification or design detail for a specific application.

www.roadstone.ie

OTHER ROADSTONE PRODUCTS



Roof Tiles

In conjunction with the traditional range of Donard, Derrie and Seville roof tiles, Roadstone also offers a more decorative range of roof tiles from Galloway to Minislate and Gemini range.

We also provide a full range of dry fitting accessories and ridge tiles.



KeltStone Walling

Roadstone KeltStone Walling is a unique masonry product designed to recreate the look of traditional Irish stone.

It blends beautifully into traditional or modern designs. KeltStone Walling can be used for the external and internal walls of your home – in traditional cavity wall construction or as the external leaf of framed buildings.

KeltStone is ideal for entrance walls, boundary walls, piers, landscaping and anywhere brickwork, stonework or plastered finished would be used.



Huntstown Brick

Roadstone Huntstown Bricks offers a unique range of colour and texture for designers, contractors and house builders alike. Concrete brick is an ideal brick for stylish and innovative building and at a cost that is unbeatable. Huntstown concrete brick are specially manufactured to reduce the risk of efflorescence ensuring a clean appearance.



Hallmark Walling

Roadstone Hallmark Walling gives a distinctive rugged cut stone appearance to the traditional Irish home, while adding charm and character to modern urban developments. Its clean yet traditional appearance adds prestige and blends beautifully with the natural landscape. It can also enhance the character of the surrounding streetscape in the urban setting.

For further details on any of the products available from the Roadstone range, please visit www.roadstone.ie or contact 01-4041200.

Roadstone is the leading supplier of building materials in Ireland. We continually strive to produce only the highest quality products and give the best service in our industry.

From raw materials to finished goods, commitment to quality in an extensive product range remains the basis of our success. A team of experienced representatives are available to advise you nationwide. Here are just some other products available from the Roadstone product range:

VISUALISE OUR
COMPLETE PAVING +
WALLING RANGE

with

PRODUCT SELECTOR

CUSTOMISE YOUR
PAVING OR WALLING
PROJECT IN 5 SIMPLE
STEPS



LEARN.

ROADSTONE ONLINE SEMINARS

NEW seminar platform offers a selection of CPD courses that address key topics within the building regulations as well as important technical advice on products and standards.

FEATURED COURSE

SuDS & PAVING

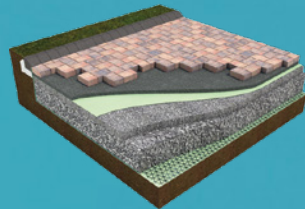

Enroll NOW on www.roadstone.ie

www.roadstone.ie

Phone: 01 404 1200

Email: info@roadstone.ie



Roadstone concrete paving blocks are produced to I.S. EN 1338:2003 Concrete paving blocks. Requirements and test methods, DOPs are available to download from Roadstone.ie

